

A3529

# Pastures for profit: A guide to rotational grazing



**Dan Undersander**  
**Beth Albert**  
**Dennis Cosgrove**  
**Dennis Johnson**  
**Paul Peterson**

# Contents

<b>Introduction</b>	1	<b>Setting up a rotational grazing system</b>	26
Why rotational grazing?	1	Setting goals and assessing resources	26
What is rotational grazing?	1	Length of rest periods	26
Who is using rotational grazing?	2	Length of grazing periods	27
Why use rotational grazing?	2	Grazing groups	28
<b>Understanding plant growth</b>	5	Spring start-up	28
Plant response to grazing	5	Seasonal fluctuations in pasture growth rate	28
Seasonal pasture growth patterns	8	Determining stocking rate and acreage needed	29
Weed control	8	Drought	30
Soil fertility	10	Moving livestock	30
Pasture establishment/renovation	10	Paddocks: How many and how big?	30
Stockpiling forage	16	Paddock layout	31
Estimating forage yield	16	Fencing	33
<b>Animal needs</b>	20	Lanes and laneways	33
Animal digestion and nutrient requirements	20	Designing a pasture system	34
Animal water needs	21	Deciding when to move livestock	35
<b>Animal grazing</b>	23	Evaluating and improving your grazing system	36
Grazing patterns	23	<b>Animal health on pasture</b>	37
Selective grazing	23	Parasites	37
Amount of available forage	24	Bloat	37
Grazing habits of different animals	24	Nitrate poisoning and poisonous plants	38
Animal impact on pasture	25	<b>Additional reading</b>	back cover





# Introduction

## Why rotational grazing?

Pastures represent a largely untapped resource for farmers. More than one quarter of the Midwest's agricultural land is in some form of pasture. Yet, 80% of these pastures suffer from poor, uneven fertility coupled with serious weed and erosion problems. Most pastures are continuously grazed throughout the season. However, continuous grazing results in the lowest possible pasture yields since the forage is not allowed to recuperate between grazing. The lack of management makes these pastures a poor forage source and most farmers are reluctant to rely too heavily on pastures to feed their high-producing livestock.

To produce good livestock feed from pasture, we must manage our pastures differently. This bulletin outlines an alternative: rotational grazing. By using rotational grazing, you can make a profit from pastures. This bulletin covers the basics of setting up rotational grazing on your farm.

## What is rotational grazing?

Under rotational grazing, only one portion of pasture is grazed at a time while the remainder of the pasture "rests." To accomplish this, pastures are subdivided into smaller areas (referred to as paddocks) and livestock are moved from one paddock to another. Resting grazed paddocks allows forage plants to renew energy reserves, rebuild vigor, deepen their root system, and give long-term maximum production.

For rotational grazing to be successful, the timing of rotations must be adjusted to the growth stage of the forage. Unfortunately, rotational grazing is often reduced to regular animal shifts from paddock to paddock based on rigid time schedules rather than in response to forage growth rate. Rigid schedules reduce the benefit of rotational grazing.

Rotational grazing can be practiced in a variety of intensities. Systems can range from 2 to 30 or more paddocks. Management intensive rotational grazing involves a higher level of management with greater paddock numbers, shorter grazing periods, and longer rest periods. Generally, more intense management results in greater livestock production per acre.



This bulletin covers the basic principles underlying all types of rotational grazing. Management intensive rotational grazing will be emphasized because it offers a number of advantages over both continuous grazing and less intensive rotational systems. These include

- more stable production during poor growing conditions (especially drought),
- greater yield potential,
- higher quality forage available,
- decreased weed and erosion problems, and
- more uniform soil fertility levels.

There are many names for intensive rotational grazing: Voisin grazing, Hohenheim grazing, intensive grazing management, management intensive grazing, short duration grazing, Savory systems, strip grazing, controlled grazing, and high-intensity, low-frequency grazing. Although each

term implies slight differences in management, they all refer to some sort of intensive rotational grazing system.

### Who is using rotational grazing?

Many farmers throughout the Midwest practice rotational grazing. Wisconsin surveys indicate that in the 1990s, the number of rotational graziers among dairy farmers has increased from essentially 0 to over 21% (figure 1). These range from a large dairy farmer who rotationally grazes 1,600 head on his 2,100 acre all-grass farm to much smaller dairy, beef, sheep, hog, and even chicken operations. Most livestock have the potential to receive a substantial amount of their feed from pasture.

### Why use rotational grazing?

Everyone with livestock and grazing land can benefit from rotational grazing.

#### Economic benefits

Most farmers try rotational grazing because of the economic savings. In Wisconsin, graziers averaged about \$200 more per cow net farm income than confinement dairy farms according to farm financial data collected from 1995 to 1999 according to University of Wisconsin Center for Dairy Profitability. During the same period, graziers averaged more than \$1.50 higher net farm income per hundredweight equivalent of milk sold than achieved by confinement dairies. Beef, sheep, and dairy heifer growing operations have also seen reduced costs and increased profit from rotational grazing systems.

Both start-up and maintenance costs are less for grazing compared to confinement systems. The only capital cost specific to rotational grazing is fencing. Costs for new fencing range from \$1.18 per acre for mobile electric fencing with fiberglass posts to \$18.37 per acre for high-tensile electric fencing. Setting up the whole system (using new fencing, fencers, and water systems) costs from \$30 to \$70 per acre. The higher price range includes the cost of constructing some livestock lanes.

**Figure 1.** Estimated percent and number of Wisconsin dairy farms using management intensive rotational grazing (MIRG), 1993–1999

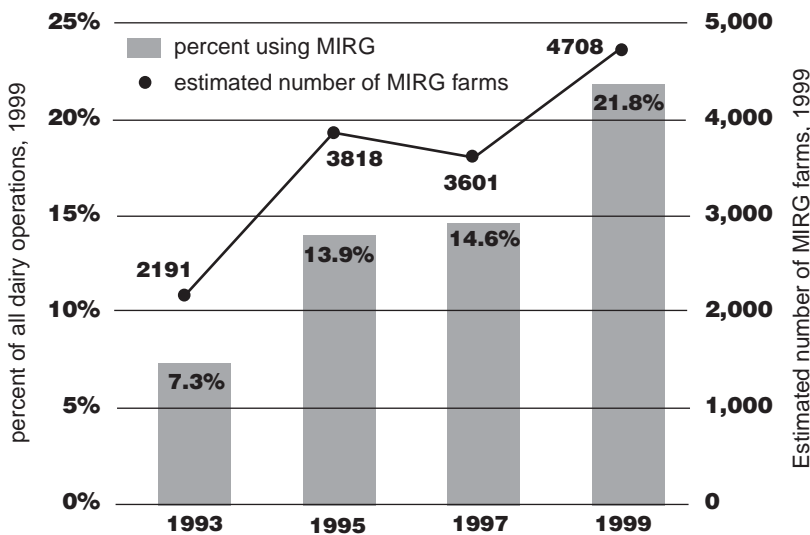

Source: Program on Agricultural Technology Studies ([www.wisc.edu/pats/dmirgperc.htm](http://www.wisc.edu/pats/dmirgperc.htm))

If you haven't already invested in confinement feeding systems, this represents a tremendous savings; if you have, maintenance costs are reduced since your confinement system needs to be operated only during the cold months. Once in operation, grazing will reduce equipment, fertilizer, pesticide, and labor costs.

Because grazing operations can be less capital intensive they can also be more financially flexible.

### **Time savings**

Many farmers are reluctant to try rotational grazing because of the time they assume it will take to move livestock. However, the time to move cattle is minimal if paddock and fencing design is efficient and cattle are moved after a milking, often averaging only 15 minutes per day. In contrast, feeding hay and silage in a confinement system may take 20 minutes to 1 hour. Grazing may also decrease your need to make hay which takes an average of 7 hours per acre each season. It also reduces the need to haul manure because most manure is dropped by the cattle on the pasture.

What if you have to move a huge herd? A large-scale stocker farmer prefers to move 250 to 500 head at a time since he has found that it takes no more time to move large groups of cattle than it does to move small groups (such as 50 or less).

### **Environmental benefits**

Well-managed perennial pastures have several environmental advantages over tilled land: they dramatically decrease soil erosion potential, require minimal pesticides and fertilizers, and decrease the amount of barnyard runoff.

Data from the USDA Natural Resources Conservation Service (NRCS) shows that in 1997, an average of 3.3 tons of soil per acre were lost each year due to sheet and rill erosion on Wisconsin cropland. In Minnesota an average of 2.1 tons of soil per acre were lost each year on cropland due to sheet and rill erosion and 5.8 tons of soil per acre per year from wind erosion.

Converting erosion-prone land to pasture is a good way to minimize this loss since Wisconsin and Minnesota's perennial pastures have an average soil loss of only 0.5 tons per acre per year from water erosion and less than 0.1 tons per acre annually from wind erosion. Reducing erosion rates will preserve the most fertile soil with higher water holding capacity for future crop production.

Pasturing helps water quality in several ways. High levels of nitrates and pesticides in our ground and surface waters can cause human, livestock, and wildlife health problems. Pasturing reduces the amount of nitrates and pesticides leaching into our groundwater in two ways: less is applied and the deeper forage root systems take up nutrients from greater depths. Pasturing also reduces contamination of streams and lakes. Nutrients contained in surface runoff enrich waters of lakes and streams with nitrogen and phosphorous which promotes excessive aquatic plant growth (leading to low oxygen levels in the water which suffocates most water life). Pastures have reduced runoff compared to cropped fields and, since cattle spend less time in the barnyard, less manure is deposited there and barnyard runoff is reduced.

### **Wildlife advantages**

Populations of native grassland birds, such as upland sandpipers, bobolinks, and meadowlarks, have declined significantly within the past 50 years. These birds once thrived in the extensive native prairies that covered the state. As the land was converted to row crops and frequently mowed hay fields, the birds' habitat has dwindled and their populations are now at risk. Many aspects of rotational grazing systems can help reverse this decline: the rested paddocks provide undisturbed nesting habitat; leaving at least 4 inches of growth in cool-season grass pastures during the spring provides needed cover for the nests; and creating large blocks (50 or more acres) that are not grazed or harvested between mid-May and early July give many young birds time to mature. Also, warm-season grass paddocks, which aren't grazed until late June, provide especially good nesting habitat. Game birds, such as pheasants, wild turkey, and quail also benefit from pastures, as do bluebirds whose favorite nesting sites are fence posts. For more details about setting up a bird-friendly grazing system, see Wisconsin Extension publication *Grassland Birds: Fostering Habitats Using Rotational Grazing* (A3715).

Pesticides can be very damaging to wildlife. Examples include some insecticides that are toxic to birds and mammals (including humans) and broad-spectrum insecticides that kill the target pest as well as beneficial insects that could help prevent future pest outbreaks. Insecticides in surface waters may kill aquatic invertebrates (food for fish, shorebirds, and waterfowl). Herbicides can also be toxic to animals and may stunt or kill non-target vegetation, which may serve as wildlife habitat. The reduced need for pesticides in rotational grazing systems benefits all.

### **Increased pasture productivity**

Rotational grazing can help improve long-term pasture quality and fertility by favoring desirable pasture species and allowing for even manure distribution. Rotational grazing also can increase the amount of forage harvested per acre over continuous grazing by as much as 2 tons dry matter per acre.

### **Aesthetics and human health benefits**

One of the greatest advantages to using rotational grazing is that it is a “peaceful way of farming.” It is quieter than mechanically harvesting your feed and it gives you the excuse to stretch your legs and take a look at what’s happening in your pasture. You might even hear the birds singing or see a deer grazing as you move the fence.

### **Animal health and welfare**

Animals in grazing systems are often healthier than animals housed in confinement. Animals have more space and fresh air, reducing their exposure to high levels of microorganisms. Increased freedom for movement enhances physical fitness and decreases opportunity for injuries and abrasions. However, risks associated with exposure to severe weather or predators may be increased in grazing.

Many have reported fewer herd health problems after switching to grazing. For many graziers, culling animals for health reasons has dropped from about 35% of the herd annually to approximately 10%. A healthier herd is more profitable and it allows the option of increasing herd size or improving the herd by selecting animals based on higher milk production or reproductivity.



# Understanding plant growth

A good understanding of the basics of plant growth is key to establishing and maintaining profitable pastures.

## Plant response to grazing

Grazing isn't "bad" for pasture plants. Pasture plants have special ways to cope with grazing. Grazing may actually stimulate pasture growth because old or dead leaves no longer shade young leaves.

Most pasture forages regrow from low-lying or underground stems, crowns, or roots, which are not grazed off by livestock. Though their growing points are protected from grazing, few of these forages are well adapted to continuous grazing. Only plants such as Kentucky bluegrass, white clover, and many prostrate weeds, whose low-growing leaves escape being completely grazed off, survive well under continuous grazing.

Taller growing forages, on the other hand, usually die under continuous grazing since most of their leaves can be grazed off. They need rest between grazings to survive in a pasture, so are well suited to rotational grazing. If allowed to grow tall, they will shade out shorter forages and weeds. Pastures that are routinely rested may have less bluegrass and a larger percentage of taller growing species, even if tall species have not been recently seeded in the field.

## Carbohydrate storage patterns

Plants get the energy needed for growth from the sun through photosynthesis which occurs in green leaves. The plant immediately converts this energy to carbohydrates which can either be used right away for growth or stored in the roots for future use (figure 2). In the fall most of these carbohydrates are stored as plants ready themselves for winter. In spring these carbohydrates are used to provide energy for early regrowth. At some point (usually at about 6 to 8 inches tall) plants are large enough and photosynthesizing enough to provide energy for growth plus have additional carbohydrates for storage. After grazing, these stored carbohydrates provide energy for regrowth until the plant is once again large enough to provide for itself through photosynthesis. This cycle repeats with each grazing until growth ceases in fall. Managing these carbohydrate cycles is the key to vigorous, long lasting stands. Grazing too frequently does not allow for replenishment of root reserves which weakens plants, slows recovery, and lowers yields.



**Figure 2.** Carbohydrate reserves at each stage of the plant growth cycle

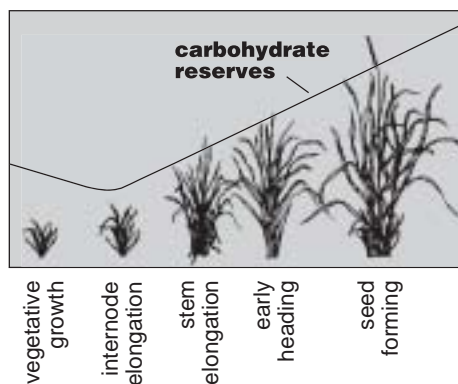



**Plant yield and quality**

Forage growth is slow when plants are small and have few leaves (early spring growth or after grazing) and yield is low. As leaves get bigger, photosynthesis increases dramatically, allowing for rapid growth and increased yields. Prior to flowering, most pasture plants are growing as fast as possible if other factors are not limiting. As plants mature, growth slows since most energy is diverted to flower and seed production. While yield is highest at heading, quality is very low. Quality is high when plants are small and vegetative and declines as plants mature. This occurs because, as plants get larger and stemmier, a greater percentage of nutrients and

dry matter is tied up in undigestible forms (such as lignin). Greater amounts of undigestible fiber result in lower quality forage with decreased amounts of total digestible nutrients (TDN).

The goal of a good grazing program should be to maximize both forage yield and quality. As shown in figure 3, the best time to graze is immediately following the most rapid growth but before flowering and seeding. Species develop differently however and the best time to graze one grass species may not be the best for another. For advice on ideal grazing heights and rest periods for various species, see the section on “Length of Rest Periods.”

**Grass growth patterns**

In the seeding year, grass seeds germinate and give rise to a single shoot. As the season progresses additional shoots called tillers develop. Removing the top growth through grazing or mowing encourages tillering. Some species such as orchardgrass, tall fescue, and ryegrass form tillers from buds on the original shoot. These are called bunch-type grasses as the tillers stay fairly close together and form discreet bunches in the field. Other grasses tiller by sending out short rhizomes which form new shoots. These grasses are known as sod-forming grasses as they form a dense sod in the field. Tillering continues throughout the seeding year and the plants enlarge. Most cool-season grasses (with the exception of timothy) don’t form seed heads in the seeding year. Buds that form in late summer are the next year’s flower buds. They must be exposed to cold temperatures during winter (vernalized) to produce flowers the following year.

**Figure 3.** Relationship between yield and quality

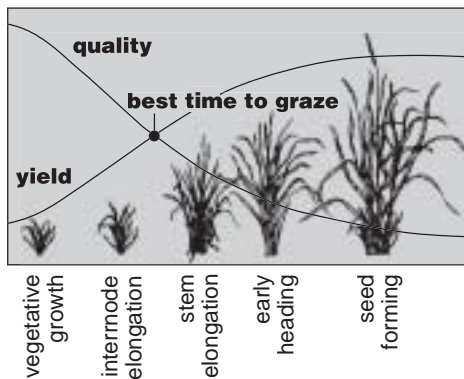

**Figure 4.** Grass development

The spring growth of the season is reproductive (produces seedheads); following grazing or harvesting, the regrowth of most species is vegetative only.

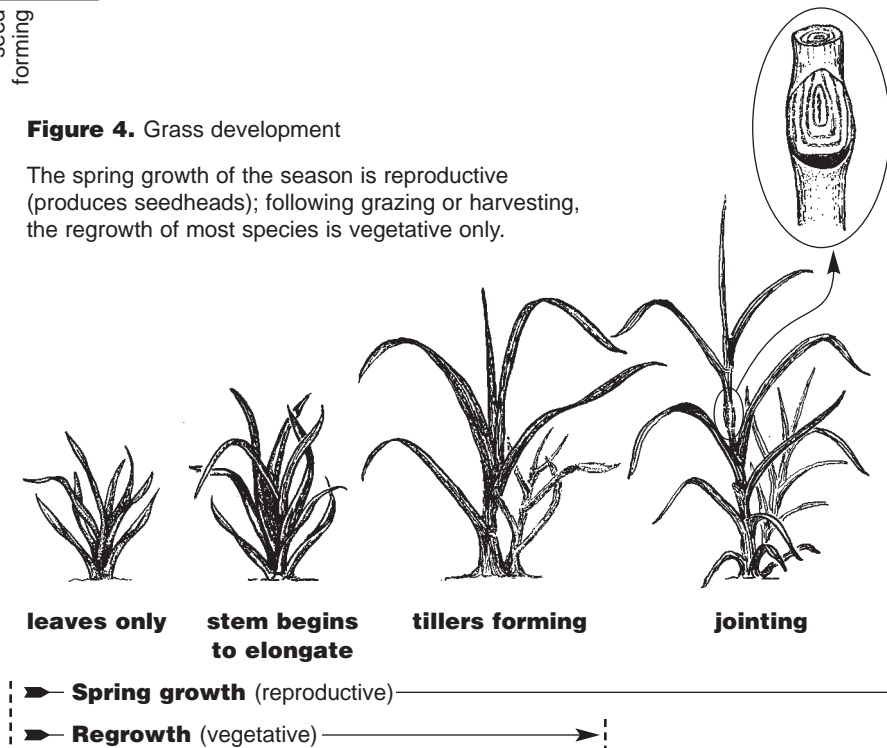

As illustrated in figure 4, after the seeding year, early growth is all leaves. The growing points that will become the seedheads are below ground and protected. Eventually the stems begin to elongate. The stage when the stems are elongating but before seedheads can be felt is known as jointing. These stems will produce seedheads if not removed. Once these shoots are removed, the plant will remain vegetative through the rest of the growing season for smooth brome grass, orchard grass, quack grass, and reed canary grass.

Some grasses such as tall fescue, perennial ryegrass and Kentucky bluegrass tiller early and produce heads profusely throughout the year. The stems of these grasses do not elongate after initially heading. As a result, these grasses may be grazed more aggressively than others.

Brome grass and timothy, on the other hand, develop tillers more slowly. Stems elongate after heading, lifting the potential growing points above the soil surface where they may be removed by grazing. These species must be managed differently than others. They should not be grazed until new tillers are visible at the base of the plant. Grazing during jointing but before new tillers form will severely damage or kill these grasses.

### Legume growth patterns

Legume seedlings consist of a single shoot. Additional shoots (tillers) eventually form from buds below the soil surface. These tillers form the crown of the plant. Like grasses, grazing or harvesting top growth encourages development of new tillers at the crown. Additional shoots also develop from above ground buds in leaf axils. Regrowth may come from buds on the crown or on stems (axillary buds) depending on severity of grazing. Some legumes, such as white clover, spread by means of prostrate stems called stolons. These types of plants are very low growing and tolerate close grazing. Legumes continue to branch and enlarge and eventually flower. Unlike grasses, legumes flower in the seeding year and several times annually every year thereafter.



## Seasonal pasture growth patterns

Ideally, forage production (or availability) should correspond with livestock needs. Livestock need forage all year round, but providing an adequate supply of yearly forage from pasture alone is difficult to do in the upper Midwest. First, the growing season is short, ranging from about 185 days in southern Wisconsin to 142 days in northern Minnesota. Secondly, pasture production is uneven during the growing season while livestock feed needs are stable or increasing (figure 5).

There are several ways to lessen this problem. One is to make hay from some pastures during periods of rapid forage growth. Also, lambing or calving before rapid spring growth will allow the period of highest animal need to match the greatest production of quality forage. Some dairy farmers have switched to seasonal milking to achieve this goal. You can even out pasture production throughout the season and extend the grazing season using the methods described below.

### Managing for more uniform pasture growth

- Healthy, unstressed plants begin growth earlier in the spring, produce higher yields during the summer, and continue growing longer in the fall.
- Switching from continuous to rotational grazing can extend the grazing season and boost yields, since rotational grazing, by virtue of its rest periods, is less stressful to the forage.
- A good fertility program will extend the season and boost yields.
- Pastures should be grazed early in the spring to help stagger growth that will occur during the flush of late May and early June.

## Weed control

Not all plants that are considered weeds in row crops are a problem in pastures. Many “weeds” such as quackgrass and lambsquarters are very nutritious at certain growth stages and need not be removed. Be concerned mainly about those plants your livestock avoid eating, that have low nutritive value such as goldenrod, or are poisonous like hoary alyssum.

Good rotational grazing systems will tend to keep most weeds out of pastures. Grazing management alone, however, will not normally correct serious preexisting weed problems without causing great losses in animal performance. Plants such as thistles, brush, and poisonous plants may continue to be a problem even after you have intensified your system since they are seldom eaten even at high stocking rates.

Before taking action, identify the weeds that are a problem in your pasture. Your county Extension agent can give you specific control recommendations. Thistles are by far the most troublesome weeds in pastures. There are two types of thistles commonly found in pastures—biennials and perennials. Each type requires different control measures.

**Figure 5.** Typical pattern of pasture production and animal needs during the grazing season

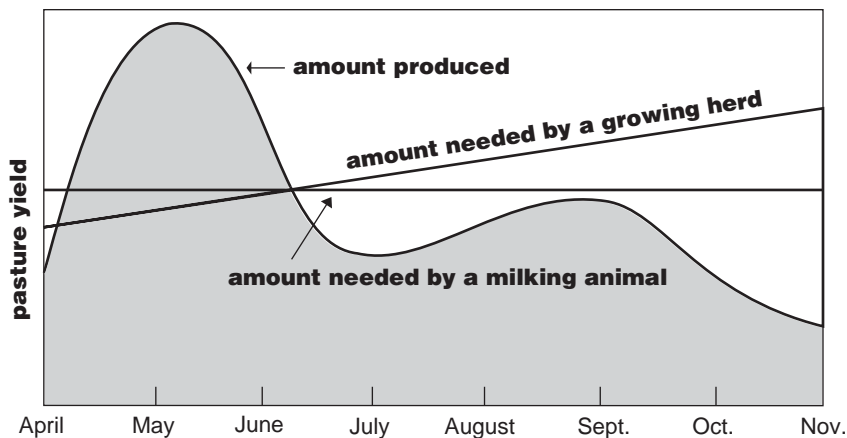

Biennial thistles live for two years. In the first year they form a group of leaves called a rosette. The rosette grows very close to the ground and usually escapes grazing. In the second year the rosette “bolts” or sends up a tall shoot, which produces flowers and seeds. After this the plant dies. Bull, musk, and plumeless thistle are in this group. These thistles should be dug up or sprayed before they set seed, preferably during their first year of growth. Biennial thistles are prolific seed producers. If allowed to set seed they will rapidly spread throughout a pasture.

Perennial thistles live for three or more years. They spread by seed and by roots. The roots can grow far from the original plant and send up shoots which themselves form roots and spread. In this way perennial thistles can spread very quickly. Canada thistle and perennial sowthistle are in this category. Digging up these thistles is impractical as new plants may form from any part of the root left behind. The most effective means is the use of herbicides. Another approach is to mow or graze the thistle patch frequently (every 10 to 14 days) throughout the growing season. These plants will eventually run out of food reserves and die or be weakened and killed over winter. The best strategy is to detect these patches early and keep them from spreading or setting seed.

### **Cultural control**

Several cultural practices help maintain a weed-free pasture. Weeds are generally more of a problem in overgrazed, infertile pastures than in fertile, well-managed pastures. Good grazing management (with pasture rest periods) and good fertility will go a long way in keeping the forage healthy and able to compete with pasture weeds. To prevent spread of weeds, avoid spreading manure contaminated with weed seeds, clean equipment after working in weed-infested pastures, and keep fencerows free of problem weeds.

### **Mechanical control**

Repeated mowing, clippings, and hand weeding can diminish weed infestations. When flower buds are closed or just starting to open, cut weeds 3 to 4 inches above the ground. Some farmers clip each paddock after every grazing period. This weakens existing weeds by depleting root reserves and prevents further spread by preventing seed production. Cutting controls bull thistle. Musk and plumeless thistles, however, commonly produce new shoots after mowing. If these shoots are not mowed, they will flower and set seed. Tillage can be used to suppress weeds as part of a pasture renovation program, but is seldom used to manage weeds in a good pasture.

### **Chemical control**

Good management greatly reduces the need for herbicides. But even with the best cultural and mechanical methods of control, serious weed problems can persist and herbicides may be needed. If weeds are a problem across the entire pasture, herbicides can be broadcast sprayed. Keep in mind, however, that most pasture herbicides will remove desir-

able legumes as well as weeds. More frequently, weeds are patchy, making spot spraying the preferred method of control. Spot spraying is less costly than broadcast treatments.

Before applying any herbicides, be sure problem weeds have been accurately identified. Wait until animals have left a paddock before spraying and do not graze treated areas until label restrictions allow.

### **Integrated control**

No single practice will produce or maintain weed-free pastures. An organized system that combines the appropriate preventative, cultural, mechanical, and chemical measures for each pasture is required. Start by evaluating the present status of your pastures and devise a 3- to 5-year plan of pasture improvement. Follow the above recommendations and with good management and perseverance, you will achieve more production from your grass and grass-legume pastures.



## Soil fertility

Many agronomic and environmental problems can be avoided by fertilizing at the correct levels. To determine fertilizer requirements, take regular soil tests and follow the recommendations given. Be sure to state the type of pasture being grown when submitting your sample because fertilizer recommendations from soil test will be based on the crop stated (or assumed) to be grown. Recommendations would be different for grass/legume pasture and tall grass pasture, for example. When switching from one type of management to another (e.g., continuous to rotational grazing), sample yearly until your management has stabilized. After that, testing every 3 years should be sufficient.

To get a good representative soil sample take 10 cores, or subsamples, and mix them together. Scrape an inch of surface soil to the side; then use an auger (works best for compacted or frozen soil), or probe to sample to a depth of 6 inches. Mix the subsamples together in a clean container to form your representative (or composite) soil sample. Transfer to a clean bag and label well. You should take one representative soil sample (about 2 cups of soil altogether) from each major soil type in your pasture or one for every 5 acres.

Fertilizer recommendations are based on a number of factors including soil type, climate, yield goals, future crop rotations, nitrogen credits from manure and legumes, pH, percent organic matter, etc. For this reason, it is important that you fully complete the soil test form. If you are not certain what types of soil are on your farm, you can obtain a soil survey

report for your county from the Natural Resource Conservation Service. Since local testing labs are more attuned to local soil types and climate, send your sample to the nearest reputable lab.

All pastures with less than 40% legume need nitrogen fertilization for optimal growth. All available nitrogen is taken up by the next cycle of growth. The most efficient use of nitrogen is to apply it immediately after each grazing cycle. However, this is generally not practical and most graziers apply nitrogen three times a year (early spring, mid-June, and early August). The spring application may be skipped if hay will not be harvested, otherwise the spring flush of growth from the entire pasture will exceed the animals' needs.

To maintain healthy pastures, manage so that soil nutrients are returned to the soil at the same rate they are removed. Once soil nutrient levels are at optimal levels, nutrients should cycle naturally in a well-managed pasture through nitrogen fixation from legumes and livestock excrement. Since grazing animals normally return 60 to 80% of available pasture nutrients (providing their manure is returned to the pasture), some additional fertilization will probably be required depending on your management and supplements being fed to animals. Pastures rotationally grazed by dairy cows receiving high levels of supplemental feeding can actually increase in phosphorus and potassium levels and thus not need maintenance fertilization.

## Pasture establishment/renovation

Before tearing up your current pasture, consider improving what's already there. Pasture renovation is less expensive than tillage and conventional establishment, provides forage more quickly, and is less risky in terms of stand loss and erosion. Many naturally growing forages may already be present in your pasture, and their yields can be improved with proper fertilization and good grazing management. In fact, just switching from continuous to rotational grazing can boost yields by up to 40%. Quackgrass, for example, is an excellent forage which makes good sod, produces high yields, and has good quality.

Many farmers use grass/legume mixtures to meet most of their production needs from pasture. Seeding legumes into run-down pastures is the most common form of renovation. Legumes reduce dependence on nitrogen fertilizer, complement grasses by balancing forage production throughout the season, and improve pasture quality.

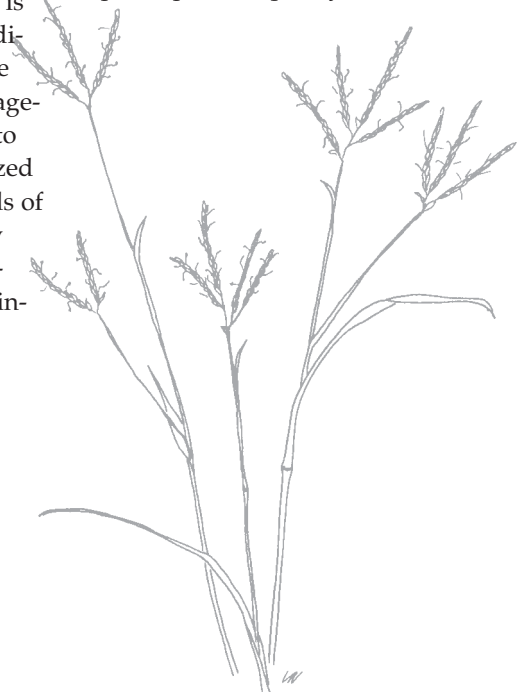

The method of renovation you choose depends on a number of factors:

- What are the current condition and species composition of the existing pasture?
- How much money and effort are you willing to spend?
- How long are you willing to take a field out of production?
- How long are you willing to wait to get good establishment?
- Are you willing to use tillage and/or herbicides?

### Seeding methods

There are a number of different approaches for establishing and renovating pastures. The following sections describe these methods.

**No-till or reduced tillage.** With this method, seed is drilled into existing sod. Modified grain drills can be used, but no-till drills are recommended because they give better seed placement and are designed to penetrate sod. Soil erosion is greatly reduced with no-till. Reducing competition from existing sod is critical to success. Options for reducing sod competition include applying a non-selective herbicide before seeding (e.g., a suppression rate of Roundup), grazing heavily the summer and fall before seeding, and/or using limited tillage to kill up to 50% of the stand. Note, though, that disking causes average soil losses of 12 tons per acre on a 15% slope and 2 tons per acre on a 6% slope.

Controlling competition during legume establishment is also critical. Typically, the suppressed sod will regrow more rapidly than new seedlings. Thus, the renovated area should be grazed at a high stocking density—enough animals to graze plants to 4 inches tall in 24 to 48 hours—when the soil is not wet to keep the regrowing sod from overtopping the developing seedlings.

**Frost seeding.** Frost seeding allows nature to assist the planting. Seed is broadcast onto pasture in late winter or early spring during or just after snowmelt. Soil heaving due to frosts helps bury the seed. Frost seeding works best on soils that shrink and swell with freezing and thawing. Moving animals across the seeding area immediately after thaw may help to incorporate the seed and improve establishment. Frost seeding is a relatively cheap method that will increase the percentage of the desired species but may produce non-uniform stands. Red clover, white clover, ryegrass, and orchardgrass can be successfully frost seeded on existing sod. These and most other species can be frost seeded on old alfalfa fields that are being converted to pasture. As with no-till and reduced till seeding, it is essential to reduce competition from the existing sod by grazing it heavily the previous fall and/or using limited tillage.

**Grazing management and patience.** Some graziers improve the species composition of pasture simply by improving grazing management. Many fields have a seed bank of desirable pasture forage species that have not had an opportunity to germinate and survive under cropping or continuous grazing. Rotational grazing provides the rest needed for these species to establish. Disadvantages of this method of “passive” renovation include the time required to observe a significant change in species composition (often several years) and the fact that alfalfa rarely appears naturally.

**Conventional seeding.** Complete pasture renovation through conventional seeding is rarely needed. However, if you are creating new pasture from cropland, the best option may be conventional seedbed preparation and planting. This works best in spring when soil moisture is adequate for germination and when plants have the entire summer to establish. Seeding can also occur in late summer if moisture is adequate. Conventional seeding can also be used for pastures in very poor condition. To renovate by conventional seeding, pastures are plowed or chiseled, worked up to reduce clods, and seeded. The advantages of tillage are that it eliminates competition from existing plants, it produces uniform pasture stands of the desired species, and it allows for incorporation of lime and fertilizer at planting. While conventional seeding is highly effective, it is costly, reduces production the year of seeding, reduces sod stability for several years, and opens the potential for significant soil loss, especially on slopes that are fall-plowed and spring-planted. To reduce erosion and minimize pasture disruption, conventional seeding should be done in strips over 2 to 3 years.

**Livestock seeding.** Using livestock to do the seeding is appropriate in terrain not accessible by equipment or where animals can graze pasture or be fed hay with seed and then be conveniently moved to pastures where the desired legume is wanted.

Livestock digest much of the legume seed and all of the grass seed they eat, so little seed is available in manure for germination. Since livestock do not distribute manure uniformly, using them as seeders will produce less uniform stands than the previously mentioned methods. It may take several years to produce good stands by this method.

There are a couple of approaches: One to two days before moving animals into the pasture, add forage seed to the mineral mix (about 5 lb seed to 50 lb mineral) or let the animals graze a pasture of established legumes (e.g., birdsfoot trefoil) that has been allowed to go to seed just before moving them to the pasture to be reseeded.

Winter grazing can be a useful tool for improving pastures, especially in terrain not readily accessible to equipment. The idea is to place supplementary forage in areas where the pasture needs to be improved so that waste feed and manure provide both seed and fertilizer. The success of this approach requires the ability to provide winter supplements at many sites in the pasture, and to move animals rapidly from site to site or even out of the pasture during muddy times when existing plants are vulnerable.

**Mixing seed with manure before spreading.** For areas that are accessible by equipment, seed can be mixed directly with manure before it's spread on pastures. This works best when manure is spread in March or early April just after snow is gone. Calculate the area covered by one load of manure and add red or white clover at a rate of 6 lb/acre.

### Selecting appropriate forages

It is most beneficial to grow a mixture of different forages in different fields on the farm. Every forage has its own susceptibilities and resistances.

Planting your entire farm to a single species is a risky venture since a single type of insect, disease, or environmental condition could easily wipe out the entire pasture.

Generally, planting one or two long-lived grass species plus a legume in a pasture simplifies management.

Tailor the selection of the forage species to the needs of your grazing system (i.e., climate, soil type, moisture level, grazing intensity, desired length of grazing season, etc.). Table 1 identifies forage characteristics which are important to compare when planning a grazing system. All of the forages listed in table 1 have some place in pastures but no single forage is best suited to all situations.



**Table 1.** Characteristics of forage grasses and legumes

<b>Grasses</b>	<b>Regrowth potential</b>	<b>Legume compatibility</b>	<b>Winter hardiness<sup>a</sup></b>	<b>Ease of establishment</b>	<b>Drought tolerance</b>	<b>Flooding tolerance</b>	<b>Species persistence</b>
<b>Cool-season</b>							
Italian ryegrass	excellent	fair	poor	excellent	fair	fair	poor
Kentucky bluegrass	good	poor	excellent	good	fair	fair	good
Orchardgrass	excellent	poor	good	good	fair	fair	good
Perennial ryegrass	excellent	fair	poor	excellent	fair	fair	poor
Quackgrass	excellent	good	excellent	n/a*	good	fair	excellent
Reed canarygrass	good	poor	excellent	poor	good	excellent	excellent
Smooth brome	fair	good	excellent	good	fair	fair	good
Tall fescue	excellent	good	fair	excellent	fair	fair	fair
Timothy	fair	good	excellent	good	poor	poor	poor
<b>Warm-season</b>							
Indiangrass	good	poor	good	poor	excellent	good	excellent
Big bluestem	good	poor	good	poor	excellent	poor	good
Sorghum/sudan	good	poor	n/a	excellent	excellent	fair	n/a
Switchgrass	good	poor	good	poor	excellent	poor	good
<b>Legumes</b>	<b>Regrowth potential</b>	<b>Bloat problem</b>	<b>Winter hardiness<sup>a</sup></b>	<b>Ease of establishment</b>	<b>Drought tolerance</b>	<b>Flooding tolerance</b>	<b>Species persistence</b>
Alfalfa	good	yes	excellent	good	good	poor	good
Alsike	poor	yes	good	excellent	poor	good	poor
Birdsfoot trefoil	fair	no	excellent	poor	poor	fair	excellent
Kura clover	excellent	yes	excellent	poor	good	fair	excellent
Ladino	poor	yes	good	excellent	poor	good	poor
Red clover	fair	yes	good	excellent	poor	fair	fair
White clover	good	yes	excellent	excellent	good	fair	excellent

N/A=not applicable

<sup>a</sup>Winter hardiness assumes use of adapted varieties

\*No seed available



## Common grasses and legumes

### Grasses

**Italian ryegrass** is a rapidly establishing grass that has high forage quality but low winterhardiness.

**Kentucky bluegrass** easily survives on infertile, overgrazed pastures in southern regions and the predominant pasture forage of northern regions. A good choice for horse pastures because it combines low maintenance and high quality.

**Orchardgrass** is higher yielding than timothy and smooth brome grass, and it recovers more rapidly after grazing. Orchardgrass is extremely competitive, so grow a competitive legume (such as red clover) with it.

**Perennial ryegrass** is an excellent choice if you want to include temporary pasture in your crop rotation. It is easy to establish, high yielding, and of high quality, but lack of winterhardiness shortens persistence to two years.

**Quackgrass** is often overlooked as a forage because it has become such a serious weed problem in row crops. It is an excellent forage, offering high yields of good quality forage.

**Reed canarygrass** may be the only forage option if flooding is a serious problem. Though difficult to establish, it is extremely persistent. Plant new, alkaloid-free varieties to improve animal intake. Be aware, though, that reed canarygrass is extremely aggressive and may invade and displace native plant communities, especially in disturbed areas.

**Tall fescue** is not recommended for pastures because of poor palatability and persistence. However, it has superior fall growth and works well in heavily trafficked areas. It is commonly used in grass waterways since it establishes rapidly. Use fungus-free seed if intending to graze.

**Timothy and smooth brome grass** are the recommended pasture forages for northern and southern regions, respectively, because of their high yield potential, high quality, and good legume compatibility. For optimal performance, they should be grown with other forages, since neither produces high yields of regrowth when grown alone.

Timothy has poor tolerance for heat and drought and lacks persistence in southern regions.

**Switchgrass and big bluestem** are native warm-season grasses that nicely complement cool-season grasses. They are slow to establish and poor competitors with weeds, but once established are persistent and vigorous. Switchgrass is easier to establish and seed is less expensive than big bluestem, but it is somewhat lower in quality.

### Legumes

**Alfalfa** is the highest yielding legume with excellent summer regrowth, persistence, and drought tolerance. However, alfalfa doesn't tolerate flooding or overgrazing, and bloat can be a problem in pure stands.

**Birdsfoot trefoil** maintains its quality better than any other legume or grass, making it a good choice for stockpiling. It is the only commonly grown pasture legume that doesn't cause bloat. Birdsfoot trefoil grows well on poor soils and is extremely persistent, with stands lasting more than 80 years! However, it is difficult to establish, relatively low yielding, easy to overgraze, and does not tolerate drought.

**Kura clover** is an extremely persistent legume that is well adapted to pasture. It spreads by rhizomes (underground stems) to form a sod. This leafy plant produces high-quality forage that can induce bloat. It does not tolerate competition during establishment because of low seedling vigor, but is very competitive once established. Reed canarygrass and orchardgrass are compatible grasses.

**Ladino and alsike clovers** are less persistent than red clover but perform well in heavily grazed pastures. They are high quality, lower-yielding forages that are tolerant of overgrazing. Alsike is especially well suited for poorly drained areas.

**Red clover** is a good choice for pastures. It persists for three to four years, is high yielding, and is the easiest and fastest legume to establish.

**White clover** is a good choice for heavily grazed pastures. It is easy to establish and very persistent.

**Combining forages for maximum productivity**

Each forage species has a distinct seasonal growth pattern (figure 6). For uniform yields throughout the grazing season, plant several forages whose growth patterns complement

each other. Forages may be mixed within a pasture if growth patterns are compatible (e.g., cool-season grass and legume) or grown in separate pastures (e.g., cool-season and warm-season grasses).

**Figure 6.** Seasonal growth patterns of forages

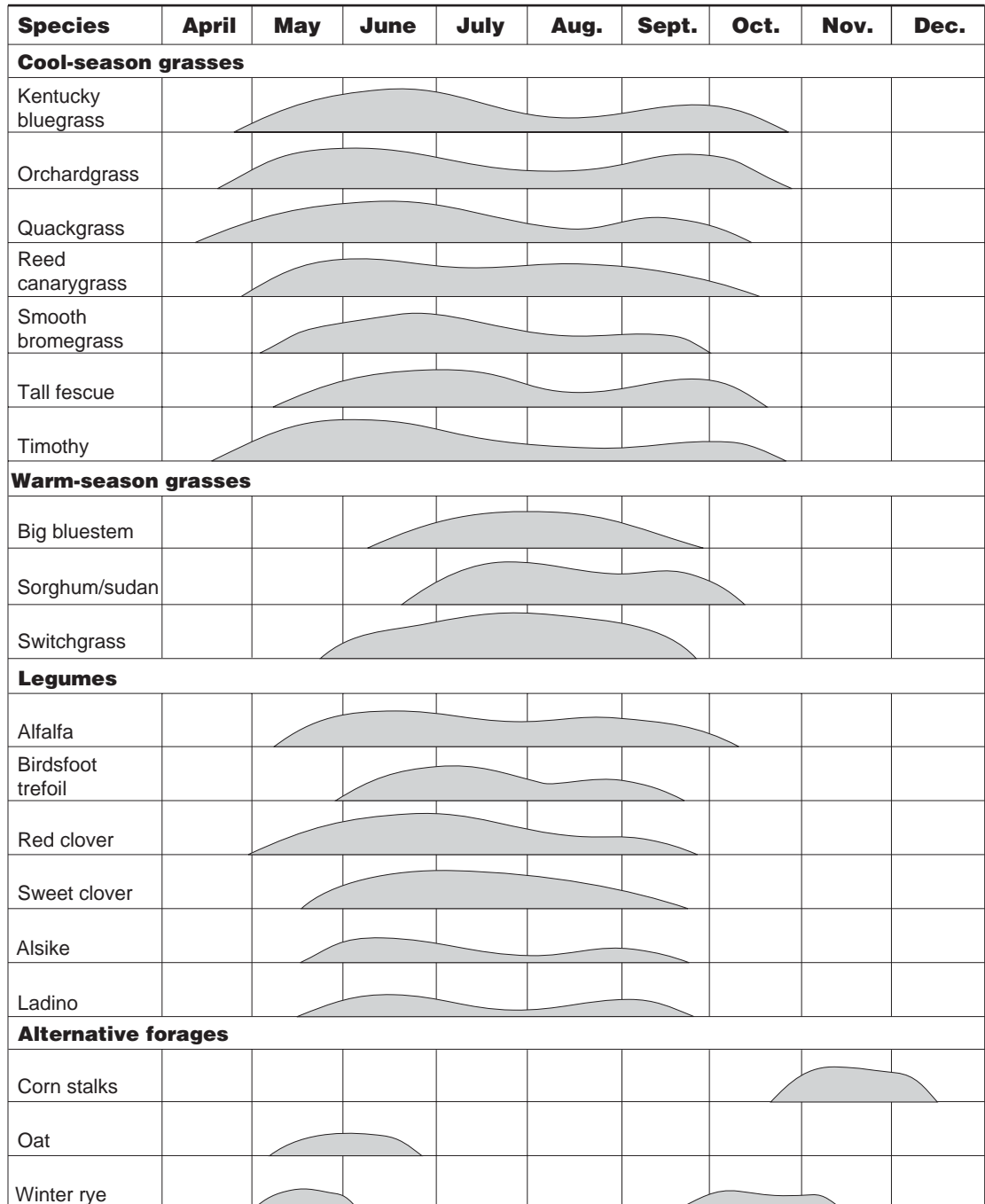

## Forage growth patterns

**Cool-season grasses** such as timothy and Kentucky bluegrass, prefer cool temperatures. They are most productive in the spring and fall but go through a “midsummer slump” in production.

**Legumes** start growing a bit later in the spring than cool-season grasses but have fairly uniform growth patterns throughout the grazing season. Many withstand heat and drought better than cool-season grasses.

**Warm-season grasses** need warm soils for germination and thrive on the midsummer heat that slows the growth of most other species. Both annuals (such as sudan-grass) and perennials (such as switchgrass and bluestem) tend to be very drought tolerant.

**Other alternative forages** such as annual grains (oats, winter rye, and winter wheat) and crop residue (e.g., corn stalks) can be grazed in the early spring and/or late fall. When grazing crop residue, leave enough residue to reduce soil erosion.

## Stockpiling forage

The length of your grazing season need not be restricted to the length of your growing season. One Wisconsin sheep farmer leaves 250 ewes on pasture all winter, giving them little supplemental feed until just before spring lambing. This is possible by stockpiling forage.

Stockpiling means allowing an accumulation of forage for later use. It is most commonly done in the late summer to provide forage for grazing after the killing frosts. The approach is to defer grazing on a portion of the pasture beginning August 1. This forage is allowed to accumulate and is grazed throughout the fall and winter after pasture growth has ceased. Spring pasture growth of birdsfoot trefoil can be stockpiled for summer grazing because it maintains leaves and quality at maturity. This practice can provide grazing during the summer slump.

The greatest limitation to late-summer forage growth is lack of nitrogen. An application of 50 lb/acre of nitrogen on August 1 will double or triple yields of deferred forages. Another way to increase stockpiled forage is to use orchardgrass, which grows more in the fall. Tall fescue also has good fall growth, but it is not very palatable for most of the growing season. Avoid stockpiling smooth brome grass and quackgrass as they produce relatively little fall growth.

If you're short on pasture, stockpiling forage for fall and winter grazing is probably not a good option since you'll have to take some of your land out of production in the early fall when forage is already in short supply. Keep in mind, however, that you can also stockpile crop residue.

## Estimating forage yield

Tables 2 and 3 give average forage yields for Midwestern states. This information gives an idea of relative comparisons and preliminary planning. You'll need to estimate yields for your own pastures as they may be considerably different from those listed due to differences in soil type, fertility, and management. To estimate your own yields, keep a record of hay yields from any of the pastures to be grazed or calculate animal grazing days and observing animal performance on the pastures. Refer to “Estimating Pasture Productivity” on page 19 for step-by-step details.

**Table 2.** Average forage yields for southern Midwest region

Species	Quality <sup>a</sup>	Yield (lb/a DM)	% Available by month					
			May	June	July	Aug.	Sept.	Oct.
<b>Cool-season perennial grasses</b>								
Kentucky bluegrass	Good	5680	30	30	10	10	15	5
	Poor	1900	10	40	10	15	15	10
Orchardgrass	Good	6440	20	35	15	10	15	5
	Poor	2260	10	30	10	20	20	10
Reed canarygrass	Good	6180	20	30	25	10	10	5
	Poor	2720	20	30	20	10	15	5
Smooth bromegrass	Good	6080	30	30	15	10	10	5
	Poor	2620	25	35	10	10	15	5
Tall fescue	Good	7940	20	30	20	10	15	5
	Poor	2740	15	40	10	10	15	10
Timothy	Good	6260	25	35	10	10	15	5
	Poor	2340	10	45	10	15	15	5
<b>Warm-season grasses</b>								
Big bluestem	Good	5000	0	10	40	35	15	0
	Poor	2520	0	15	40	35	10	0
Switchgrass	Good	5000	0	15	35	35	15	0
	Poor	2500	0	15	45	35	5	0
Sorghum/Sudangrass	Good	5500	0	0	20	30	30	20
	Poor	3000	0	0	40	45	15	0
<b>Legumes</b>								
Alfalfa/grass	Good	5820	20	25	35	20	0	0
	Poor	3000	20	25	35	20	0	0
Birdsfoot trefoil	Good	5120	10	50	30	10	0	0
	Poor	2500	10	50	30	10	0	0
Red clover/grass	Good	5500	25	40	20	10	5	0
	Poor	2750	25	40	20	10	5	0
<b>Alternative forages (cool-season annual grasses)</b>								
Oat	Good	3000	55	35	10	0	0	0
	Poor	1600	60	40	0	0	0	0
Winter rye	Good	2800	55	25	0	0	5	15
	Poor	1200	65	25	0	0	5	5
Winter wheat	Good	2800	55	25	0	0	5	15
	Poor	1200	60	30	0	0	5	5

<sup>a</sup>**Quality:** Good = Lime and fertilizer have been applied. Rotational grazing.  
 Poor = No fertilizer added. Continuous grazing.



**Table 3.** Average forage yields for northern Midwest region

Species	Quality <sup>a</sup>	Yield (lb/a DM)	% Available by month					
			May	June	July	Aug.	Sept.	Oct.
<b>Cool-season perennial grasses</b>								
Kentucky bluegrass	Good	4700	30	20	20	10	15	5
	Poor	1240	15	45	15	10	10	5
Orchardgrass	Good	5580	25	20	20	15	15	5
	Poor	1520	20	35	20	10	10	5
Reed canarygrass	Good	5460	25	20	30	10	10	5
	Poor	1940	25	30	20	10	10	5
Smooth bromegrass	Good	4900	35	20	20	10	10	5
	Poor	1780	30	30	15	10	10	5
Tall fescue	Good	6000	15	25	20	15	15	10
	Poor	1740	20	45	15	5	10	5
Timothy	Good	4800	25	30	15	10	15	5
	Poor	1600	15	50	10	10	10	5
<b>Warm-season grasses</b>								
Big bluestem	Good	3500	0	0	25	50	25	0
	Poor	2520	0	0	30	45	25	0
Switchgrass	Good	4830	0	0	35	50	15	0
	Poor	2170	0	0	30	45	25	0
Sorghum/Sudangrass	Good	5500	0	0	20	30	30	20
	Poor	3000	0	0	40	45	15	0
<b>Legumes</b>								
Alfalfa/grass	Good	5540	20	30	30	20	0	0
	Poor	3000	20	30	30	20	0	0
Birdsfoot trefoil	Good	4320	10	40	35	15	0	0
	Poor	2500	10	40	35	15	0	0
Red clover/grass	Good	5500	20	30	30	20	0	0
	Poor	2750	20	30	30	20	0	0
<b>Alternative forages (cool-season annual grasses)</b>								
Oat	Good	2500	55	35	10	0	0	0
	Poor	1600	60	40	0	0	0	0
Oat + rape	Good	2410	30	45	25	0	0	0
	Poor	1600	30	45	25	0	0	0
Winter rye	Good	2300	55	25	0	0	5	15
	Poor	1200	65	25	0	0	5	5

<sup>a</sup>**Quality:** Good = Lime and fertilizer have been applied. Rotational grazing.  
 Poor = No fertilizer added. Continuous grazing.



## Estimating pasture productivity—two methods

### Direct estimate method

Example weights are given for each step and are used in the final calculations.

1. **Clip and collect** the forage in 1 square yard of pasture. Clip at the intended grazing height; this will vary with species.
2. **Weigh and record the forage.** Take all measurements in pounds (example: 2.07 lb/sq yd).
3. **Dry a sample:**
  - a. Record the weight of an empty paper plate (example: 1 oz).
  - b. Take a half pound (approximately) sample of the forage. Place it on the plate and weigh it accurately (example: 9 oz).
  - c. Place the sample in a microwave oven along with a cup of water. Microwave on high for 3 minutes, then weigh the sample. **Note:** It is extremely important to leave water in the microwave throughout the drying process. Water reduces the chance of ruining the microwave or possibly starting a fire.
  - d. Microwave the sample for another minute, then reweigh the sample. Repeat this step until the weight remains the same.
  - e. Record the final sample weight (example: 3 oz).

### 4. Calculate percent forage dry matter (DM):

$$\% \text{ forage dry matter} = \frac{(\text{final weight of sample}) - (\text{weight of plate})}{(\text{original weight of sample}) - (\text{weight of plate})}$$

Example:  $\frac{3 \text{ oz} - 1 \text{ oz}}{9 \text{ oz} - 1 \text{ oz}} = 0.25$  (25% forage dry matter)

### 5. Determine pasture yield:

$$\text{Pasture yield (lb/acre)} = \frac{[\text{total weight of forage (step 2)}] \times [\% \text{ forage DM (step 4)}] \times (43,560 \text{ sq ft/acre})}{(9 \text{ sq ft/sq yd})}$$

Example:  $\frac{2.07 \text{ lb/sq yd} \times 0.25 \times 43,560 \text{ sq ft/acre}}{9 \text{ sq ft/sq yd}} = 2505 \text{ lb/acre}$

### Pasture plate method

A much faster way to estimate yield is through use of a pasture plate. You can make your own plate using the following directions:

**Materials:** An 18-inch square sheet of acrylic (0.22-inch thick), a yardstick, and a 2-inch bolt.

**Assembly:** Drill a 1.5-inch hole in the center of the plate. To make it easy to lift and carry the plate and yardstick together, insert a large bolt through the bottom of the yardstick.

**Procedure:** Place the yardstick on the ground. Hold the plate (on the yardstick) 1 foot above the standing forage and let it drop. Record the plate's height (in inches) off the ground. Take measurements in 5 to 10 locations in the pasture and use the average height. To calculate dry matter yield (lb/acre), multiply the height by 390. For accurate results, the plants must be dry when taking measurements.

$$\text{Pasture yield (lb/acre)} = 390 \times \text{height (inches)}$$

Example:  $390 \times 6 \text{ inches} = 2340 \text{ lb/acre}$

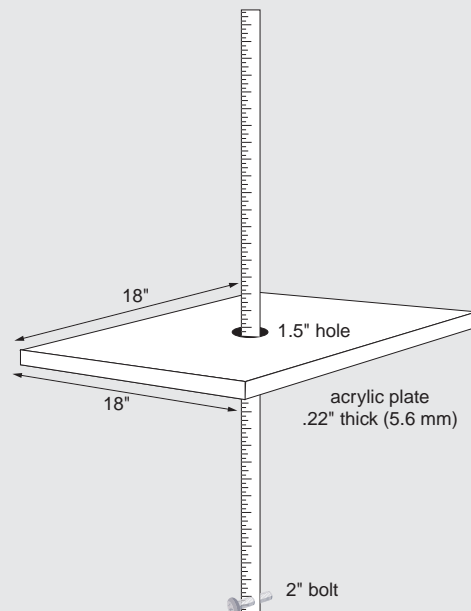



# Animal needs

## Animal digestion and nutrient requirements

Ruminants, such as cattle, sheep, and goats, are “natural grazers” having a rumen full of microbes that break down most plant fibers. Because of their efficient digestive system, ruminants can usually obtain most of the nutrients and energy needed for growth and production from good quality pasture alone.

Horses are “pseudo-ruminants.” They don’t have a rumen, but do have microbes in an enlarged cecum which digest some plant fiber. Therefore, horses must graze longer than true ruminants to get adequate nutrition.

Pigs and poultry are non-ruminants with smaller digestive tracts in which relatively little fiber digestion occurs. They get nutrition from nonfibrous portion of plants and from seeds. In addition to pasture forage, they must be fed high-energy supplements to get the nutrition needed for growth.

High-producing dairy cows require supplementary feeds to fulfill their ability to produce milk. Table 4 shows that high-quality pastures largely meet the requirements for protein, but even legume pastures will not provide for adequate intake of energy. Supplements should be formulated to complement the grass or legume growing in the pasture. Generally grass pasture requires a supplement high in energy with moderate protein levels. Legumes come closer to meeting the requirement of high production, so less supplement is needed.

**Table 4.** Nutrient needs for cows in early lactation and what pastures supply

Nutrient	Recommendation	Grass	Grass-legume	Legume
Net energy of lactation (NEL), Mcal/lb	0.78	0.65–0.70	0.66–0.72	0.68–0.74
Crude protein (CP), % of DM	19	18–22	21–23	23–25
Escape protein	7.2	4.6–4.3	4.2–5.7	4.6–5.0
Neutral detergent fiber (NDF), % of DM (min)	28	50	44	38
Nonfibrous carbohydrate (NFC), % of DM	36–40	15–20	15–20	20–25

*Adapted from Cherney, D.J.R., and J.H. Cherney. 1999. Feeding forages for optimum performance and pasture sustainability. Cornell Nutrition Conference for Feed Manufacturers*

Figure 7 shows energy requirements of livestock in relation to the quality of various forage types. Quality, in this case, is represented in terms of total digestible nutrient (TDN) levels. As shown, each forage type has a different range of total digestible nutrient levels and each animal species and breed has a different range of nutrient requirements. Nutrient requirements vary with the animal species, sex, maturity, size, and whether or not the animal is lactating. To maximize production, you must match livestock nutrient requirements with forage TDN levels. High-producing dairy cows, for example, could probably not get enough nutrients from cool-season annual grasses alone but must be given a high percentage of legumes and be fed supplement. Most animals can be maintained at TDN levels of 45 to 50%.

**Figure 7.** Ruminant nutrient requirements

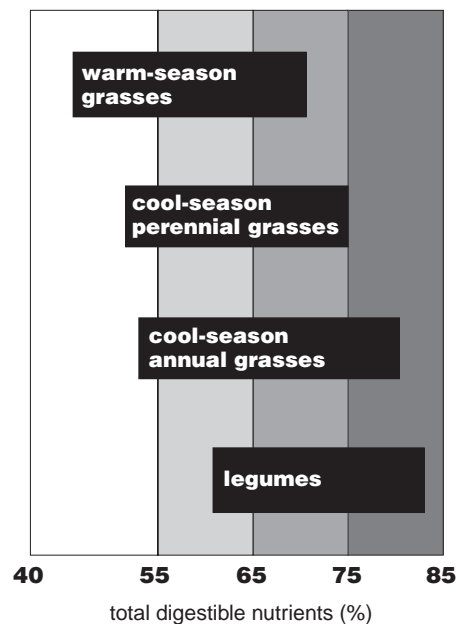

Most of the mineral needs of livestock can be met by the pasture alone. The exception would be if you are grazing crop residue, such as corn stubble. Salt, however, should always be provided to animals “free choice.” When selecting a salt, it is a good idea to buy a trace mineralized salt just to make sure mineral requirements are being met.

### Animal water needs

Although livestock can get the majority of their water from lush forage which is 70 to 90% water, a good supply of clean water is essential in a grazing system, especially on warm and sunny days. Livestock water requirements are shown in table 5. Remember, though, that an animal’s water needs vary with temperature, humidity, animal size, milk production, and diet. For example, dry stock grazing lush grass in early spring or grazing snow-covered pastures in winter may not need additional water while milking dairy cows in the same conditions would need water.

**Table 5.** Daily water requirements of grazing animals<sup>a</sup>

Animal	Gallons per day
Beef cows	15–20
Dairy cows	20–30
Yearling cattle	10–15
Sheep	2–3
Horses	10–15

<sup>a</sup> These are average figures. Water needs will be greater on hot, dry days and/or when grazing on dry forage. Needs will be less on cool, rainy days and/or when grazing on lush forage.

- Low nutrient requirements.** Most dry or maintenance stock fit into this category. For example, a dry ewe or dry cow.
- Medium nutrient requirements.** Lactating sheep, goats, and horses, or fattening lambs. For example, a ewe and nursing lamb or a lactating horse.
- High nutrient requirements.** Any beef steer or heifers or cow/calf pairs. For example, a stocker with an average daily gain of 2 pounds.
- Very high nutrient requirements.** Only high-producing dairy cattle are included in this class. For example, a milking cow giving 60 pounds of milk per day.



### Access to water

Ideally, water should be available within about 800 feet of the maximum distance from which cattle might have to travel in a grazing system. Missouri research indicates that animals will not graze much farther from water than this. Performance per animal is generally reduced when cattle are forced to travel more than a quarter mile to access water.



**Figure 8.** Movable 55-gallon drum fed by garden hose with float

Some farmers use lanes to access a central watering site, but the ideal system is to have water available within every paddock. This reduces the distance livestock must travel to drink, discourages livestock from congregating around a central water source, and requires less fencing. Often, pasture is severely trampled and eroded near central watering sites, wasting forage and compacting the soil.

If you choose to use a natural water source, consider siphoning water to your livestock rather than bringing them to the source. This reduces disease and parasite problems and preserves water quality. To make pumping easier, moveable solar or battery powered pasture pumps are available.

Plastic tubing laid on the ground can be used for carrying water. That way it is movable and temporary. To maintain water pressure, it works best to use larger diameter tubing to transport water to the pasture (e.g. 1-inch diameter) and smaller diameter tubing (e.g.  $\frac{5}{8}$ -inch diameter) to give water to the paddocks.



**Figure 9.** Single tank watering two pastures

### Size of waterer

The size waterer you'll need depends on the distance between the water and your animals. Any time there is considerable distance between the herd and the water source, getting a drink involves travel and thus becomes a social function involving the movement of large animal groups. Under these conditions, use a separate water trough for each 50 to 60 head or have it large enough for 10% of the head to drink at one time. The tank must also hold enough water for the entire herd to drink once (e.g. 50 cows x 10 gallons/cow = 500 gallons) since minimal refilling can occur from the well in one drinking session.

Under intensive grazing (paddocks smaller than 10 acres), where water is provided in every paddock, going to water is an individual function. Under these conditions, a portable 50-gallon tank (with a demand valve attached to a float to regulate water level) can easily water 100 head of cattle. Or, a 100-gallon container can serve two paddocks when located between them. A 10-gallon container with a demand valve will be large enough to water 100 smaller livestock such as sheep and goats. Portable waterers need not be fancy; 55-gallon drums cut in half will work. Tanks can be put on wheels or skids to ease movement. Lightweight plastic or fiberglass containers are available in various sizes.

# Animal grazing

## Grazing patterns

Most livestock prefer not to graze during the hottest part of the day, so the heaviest grazing period occurs after sunrise for two or three hours. Grazing increases again as temperatures drop towards evening. A third grazing period may occur around midnight. On average, 60% of grazing occurs during the day and 40% occurs during the night with livestock spending more time grazing at night following hot days. During very hot weather, animals need abundant water and may benefit by being moved to shade during the hottest hours of the day.

Time spent grazing differs with species. Generally, cattle graze about 8 hours per day, sheep 7 hours or less, goats no more than 6 hours, and horses 12 to 16 hours per day.

The time spent grazing each day is roughly the same regardless of pasture quality or yield. Animals will quit grazing after the normal grazing time, whether or not they have gotten all the energy and nutrients they need for weight gain or milk production. To maximize production, livestock must receive a sufficient amount of high quality forage during their grazing period.

## Selective grazing

Livestock are naturally selective in what they eat. They will always select the most nutritious, best tasting, and easiest-to-eat forage. Livestock favor certain forage types over others (forage favorites may change during the season).

Selective grazing can be a problem when the stocking density is too low. Some spots are grazed down while other areas are allowed to go to seed. As soon as a preferred forage plant begins to regrow after having been grazed, it will most likely be eaten again since it tastes better (and its quality is higher) than older forage in the pasture. This is called spot grazing.

Spot grazing causes yield losses in two ways: First, the areas that mature are lost because forage quality drops too low. Second, the regrazed spots never have a chance to reach a height that allows rapid growth. Forage production in the heavily grazed spots is therefore reduced.

Spot grazing also favors poor forage composition in pastures. High-quality forage species die out from overgrazing, while unpalatable types flourish. Legumes are usually the first plants to be lost.

Rotational grazing, particularly management intensive rotational grazing, reduces spot grazing. Higher stocking densities in rotational grazing systems cause livestock to graze more uniformly and completely. High-quality forages, such as desirable grasses and legumes, thrive because they are given a rest period. Well-managed, rotationally grazed pastures usually have few weed problems.



Livestock selectively graze certain plant parts over others. Animals eat from the top down, taking the youngest, most nutritious leaves first, leaving less nutritious fibrous stems for later. Because of their small mouths, sheep and goats can graze more selectively than cattle. For this reason, sheep need to graze more closely than cattle to get an even graze. If livestock are forced to graze a pasture down to the stems, however, they will perform poorly (gain less weight or produce less milk) because they get less high-quality forage per bite. To best use your pasture, let high-producing livestock graze first followed by a “clean-up crew” of animals with lower nutritional needs.

### Amount of available forage

The amount of forage on offer also influences consumption. The taller and denser the forage, the more forage an animal will get per bite. However, when forage is tall (over 10 inches), large amounts are wasted because of trampling. If forage is short, animals waste energy trying to get enough to eat with little bites. If ground can be seen when looking down through the forage, the stand is likely too thin and stand density will limit forage intake. When forage is too short or thin, animal intake will decline and animal performance will suffer. Keep these factors in mind when deciding at what height to graze. Each forage species has a different height at which it does best when grazed. For more information, see the section on length of rest periods in “Setting Up a Rotational Grazing System.”

### Grazing habits of different animals

Different animal species have different grazing behaviors. In addition, the animals eat different forage species in different ways. Their dietary preferences are shown in table 6. If grazing more than one species of livestock, it is best to graze the picky grazers first and follow with the less picky eaters (e.g., horses or cattle followed by sheep or goats).

Cattle typically tear off large mouthfuls of forage. Older cows are spotty eaters. They avoid zones near manure drops and eat other areas very close to the ground. With proper grazing supply management, yearlings graze quite uniformly, often to the base of leaves.

Horses are spotty eaters and tend to bite off forage close to the ground. They are extremely picky grazers and rarely touch weeds and woody species.

Sheep and goats bite off plants close to the ground, which may lead to overgrazing when forages are scarce. Close grazing by sheep and goats coupled with their sharp hoof action may lead to erosion problems, especially on overgrazed slopes. Goats prefer the leaves and stems of woody plants over grass and can be used to clear land. Sheep will eat more weeds.

Pigs, natural rooters, may eat entire plants, root and all, which they dig and pull out of the ground with their snouts; this is very disruptive to a pasture. They are excellent grazers, however, when snout rings deter them from rooting.

Fowl will strip the soil bare if allowed to, eating everything including roots and soil insects. They can be used to weed and fertilize land for small-scale planting.

**Table 6.** Diet selection of livestock

Type of diet	% of diet			
	Horses	Cattle and red-tailed deer	Sheep	Goats and white-tailed deer
Forages (grasses and legumes)	90	70	60	20
Weeds	4	20	30	20
Woody material	6	10	10	60

## **Animal impact on pasture**

Livestock impact pastures in a variety of ways besides simply harvesting forage. They tread on the soil, trample the forage, and disperse manure.

### **Treading and compaction**

Some animal treading breaks up the soil surface allowing better water penetration and is not harmful to pasture plants. However, excessive treading (as seen in cow paths or livestock lanes) can compact soil.

Rotational grazing minimizes compaction since the soil is given time to recover after grazing. Keeping animals off of a pasture when it is very wet will reduce both soil compaction and plant damage.

Erosion, which can be a problem in continuously grazed pastures where animals walk or in camp areas (near shade, feed, water, gates, etc.), is minimized in a rotational system since livestock are prevented from treading on the same area day after day.

Sod-forming grasses like smooth brome grass, reed canarygrass, and Kentucky bluegrass are very tolerant of heavy traffic. Adding any of these species to a pasture mix will greatly increase the treading tolerance of the pasture. Paddocks with only bunch or crown-forming plants like alfalfa, orchardgrass, and timothy are not tolerant and should not be grazed when the soil is wet.

### **Manure**

Manure is a very important source of recycled nutrients and should be managed to the benefit of the pasture. With continuous grazing, manure is not effective as a fertilizer because grazing animals concentrate manure in areas where they congregate, not where they graze. As a result, some areas of the pasture receive few nutrients while other favorite areas become overloaded. Rotational grazing greatly improves manure distribution across growing pastures and reduces maintenance fertilizer costs.

Grazing lush vegetative growth also helps distribute manure more uniformly and accelerates the breakdown and recycling of manure nutrients because manure is more liquid than when coarse, overmature forage is consumed.

Manure is an important contribution to a pasture providing both nutrients and organic matter. One cow can excrete 50 pounds or more of manure in a day! Animals will usually avoid eating near manure of their own species but will eat right up to manure of a different species. Cattle, for example, will avoid eating near a fresh cow pie. At first, this avoidance is most likely due to odor which leaves after two to three weeks. By the time the odor is gone, the ungrazed forage has become more mature and less palatable than the surrounding forage and will consequently be avoided. You can take advantage of this behavior by spreading manure in an area of the pasture to keep livestock off.

Rejection of forage surrounding manure cannot be avoided but it can be lessened. Higher stocking rates will decrease the “zone of distaste,” but animals should never be forced to eat right up to manure of the same species since it often contains harmful parasites. High stocking rates will also help break up manure (through hoof action), speeding decomposition. Following one species of animal with another will promote more uniform forage consumption and can help to break up parasite cycles. To obtain additional nutrients, some animals (such as pigs) will actually eat the manure of another species!



# Setting up a rotational grazing system

## Setting goals and assessing resources

The first step in starting a grazing system on your farm is setting management goals. Well-defined goals and an assessment of your pasture resources will determine how you design your system. Goals should be written to plan for profit, responsible land stewardship, and the grazer's personal needs and wishes. The following questions may help you get started:

### Goals

- Are you grazing to maintain a herd, to achieve maximum production, or to clear land?
- If grazing to achieve maximum production, do you want to maximize production per animal or per acre?
- How intensive do you want your management to be?
- Are you willing to fertilize?
- Are you willing to feed supplemental grain or hay or do you want to avoid running out of forage?
- Do you want productive pastures right away or can you gradually work up to higher yields?
- Do you have severe weed problems such as thistle and brush which must be taken care of before you intensify your system?

### Resources

- How much capital is available to invest for starting a grazing system?
- Do you have a shortage or an abundance of pasture?
- What forage species are currently in the pastures?
- What is the condition of the pastures? Fencing?

## Length of rest periods

How does a person determine the appropriate rest period to give a paddock? For optimum production, pastures should be grazed about a week before the grass heads out (goes to seed) or when the legume is in the early or mid bud stage. Table 7 outlines the average heights at which to begin grazing grasses and legumes. At these heights, pasture quality is high, forage is easy to eat, and plants have recovered sufficiently from the previous grazing.

The rest period required is closely related to seasonal forage growth (see figure 6).

- Legumes such as alfalfa, birdsfoot trefoil, and red clover need rest periods of about 3 to 4 weeks throughout the season.
- Cool-season grasses such as Kentucky bluegrass, ryegrass, orchardgrass, or timothy need as little as 2 weeks of rest during cool weather and 5 to 7 weeks during hot weather.
- Grass-legume mixes should be grazed when the grass reaches the ideal height.
- Warm-season grasses, such as sorghum/sudan or big bluestem, need to rest for 5 to 6 weeks during cool weather and about 3 weeks during hot weather.

Plants under stress (drought, cold weather, poor soil fertility, etc.) will require longer rest periods. Optimal growing conditions, on the other hand, decrease the rest period needed. If you must abuse a pasture (by overgrazing and/or using short rest periods), do it when growing conditions are optimal such as in the spring.

The above guidelines provide a starting point for deciding when to graze and how long of a rest period is needed, but they must be fine-tuned to fit your system. It is crucial that you move your animals according to the forage, not the calendar. If you graze too early, the pasture will be set back, desirable plants may die out, and weeds may take hold. If you graze too late, the grass becomes bunched, loses palatability, and your production might suffer. There are times when you'll want to purposely use shorter rest periods to weaken a pasture (say for interseeding legumes) or keep up with unusually fast growth. There are also times when you'll need to use longer rest periods to let forage reseed itself, renew its root reserves, or be stock-piled.

### Length of grazing periods

Controlling the amount of time a paddock is grazed is just as important as leaving adequate rest periods between grazing. If the grazing period is too long, newly grazed plants may grow back tall enough to be regrazed again within the same

grazing period and can be damaged. Regrowth occurs after about four days during May and June and 10 days during August and September, so the maximum grazing period should never be longer than these averages.

Use short grazing periods. Since livestock graze selectively, they will eat highest quality forage when first turned out onto a paddock and be forced to eat lower quality forage each day they remain in the same paddock. They also tend to eat more when first turned out onto a fresh paddock. Therefore, shorter grazing periods will provide for more uniform forage intake. This is especially important for dairy farmers since change in forage quality shows up in milk yields. Many dairy farmers use one-day grazing periods; some move livestock after every milking. With other types of livestock, rapid moves are less beneficial and animals may be moved to new pasture every 2 to 6 days depending on the level of nutrition required.

Do not overgraze pastures. The closer you graze a pasture, the longer the rest period required for forage recovery. The higher the stubble, the more quickly the plant will be able to recover after grazing. A good rule of thumb is to leave 4 inches of stubble for cool-season grasses and legumes and 4 to 8 inches of stubble for warm-season grasses. Try to adjust the length of your grazing period to allow for these stubble heights. If you can't leave these stubble heights, your forage will probably do all right if you give it adequate rest between grazing. A sure way to kill desirable species is to graze close and then graze the regrowth without allowing adequate rest.

**Table 7.** Average heights to begin and end grazing

Species	Plant height (inches)	
	Start grazing	Stop grazing
<b>Tall-growing cool-season grasses</b> orchardgrass, quackgrass, reed canarygrass, smooth bromegrass, tall fescue, and timothy	8–10	4
<b>Tall-growing legumes</b> alfalfa, alsike clover, birdsfoot trefoil, kura clover, ladino clover, and red clover	8–10	4
<b>Ryegrasses</b> Italian and perennial	6–8	2
<b>Short-growing cool-season grasses and legumes</b> Kentucky bluegrass and white clover	4–6	2
<b>Warm-season grasses</b> big bluestem, indiagrass, sorghum/sudangrass, and switchgrass	12–14	4–6

If cattle are leaving excessive forage, you may wish to decrease your paddock size instead of lengthening the grazing period. You may have to lengthen the grazing period and/or increase the size of your paddocks midseason to correspond to decreasing forage growth rates.

### Grazing groups

To make the most out of your pasture, it is often beneficial to divide livestock into different groups based on nutritional requirements for desired performance levels. This way, you can allow the animals requiring the highest level of nutrition to get the highest quality forage while saving the lowest quality forage for the animals with lower nutritional requirements. There are several possibilities which should be modified to your own situation. A herd can be divided into two or three groups. Table 8 shows examples of this.

There are two ways to best use forage to meet animal needs:

- 1) Graze more than one group on the same paddock sequentially. High producers should be grazed first (to consume the highest quality forage), animals with lower nutritional needs should graze second, followed by animals with only maintenance requirements (dairy cows followed by heifers and dry cows, or lambs followed by ewes).

- 2) Graze different groups in separate paddocks. If you have some poor quality pastures, let the animals with lower nutritional needs graze them.

Note: Animals with only maintenance requirements can be used to clear land if used at high stocking rates (approximately 170,000 lb/acre). Goats are especially good for this since they prefer woody forage. When using animals to clear land, don't leave them on so long that they're forced to eat poisonous plants.

### Spring start-up

There are two problems that you must deal with when getting started in the spring. The first is getting your animals used to consuming fresh feed after a winter of eating stored feed. Make the transition gradually to allow the rumen microbes to adjust. Don't turn hungry livestock onto pasture to start out with, as they may eat too much and bloat. To guard against bloat, see bloat in "Animal Health on Pastures."

The second problem has to do with the pasture. The entire pasture will be growing at about the same rate but you will be grazing small sections at a time. This means that the paddocks you leave for last probably will over-mature unless you compensate somehow. You can try one of three alternatives:

- 1) Spread spring green-up by staggering the last grazing in the fall.
- 2) Graze a large paddock or the entire pasture when the plants are only 2 to 3 inches tall and gradually reduce the size of the paddock as the forage gets ahead of the animals. Reduce paddock size by about 30 to 50% as grass height reaches 6 inches. This will help stagger pasture growth throughout the season.
- 3) Make hay or mow pastures that get ahead. For instance, plan to make hay from about half of your pasture (make sure it is not too steep, rocky, or wooded to be hayed) during the first grazing cycle.

During wet springs, avoid mud problems by grazing paddocks located on high, dry land.

### Seasonal fluctuations in pasture growth rate

There are a number of ways to provide high yielding, quality forage throughout the grazing season.

- 1) Reduce the number of paddocks grazed in the spring by using them to make hay. Put those paddocks back into the rotation in the middle of the summer and, if necessary, supplement your grazing animals with the hay made in the spring.
- 2) Plant portions of pasture to different species to stagger heading.
- 3) Plant legumes in cool-season grass pastures to provide more even summer growth (see figure 6).

**Table 8.** Grazing groups based on nutritional needs

Livestock	High performance	Moderate performance	Maintenance
Dairy	dairy cows	heifers	dry cows
Beef	steers and heifers for meat production	cows with calves and growing heifers	dry cows
Goats	milking does	does with kids	dry does
Sheep	weaned lambs	ewes with lambs	dry ewes

## Determining stocking rate and acreage needed

### How many animals should be put in a pasture?

The answer to this question about stocking rates depends on your goals. If you have a limited amount of pasture land but a flexible herd size, you'll probably benefit from going to a more intensive system. If you don't plan on feeding supplement and/or are more concerned about individual animal gain than gain per acre, you may wish to stock at a lower level.

The calculations below will give a rough estimate of the maximum number of animals that can be grazed on your land.

- 1) Determine total pasture acreage for the season (example: 20 acres).
- 2) Estimate average pasture yield per acre. For average yields of various forage mixtures see tables 2 or 3 or use your own figures if you have them (example: 4000 lb/acre).
- 3) Estimate the length of your grazing season in days (example: May 15 through October 15 or 153 days).
- 4) Estimate the average weight of one of your animals for the season

$$\text{Average weight} = \frac{(\text{beginning weight} + \text{predicted final weight})}{2}$$

Some average weights:

dairy cow (Holstein) = 1300 lb	horse = 1250 lb
beef cow = 1000 lb	goat = 170 lb
beef bull = 1250 lb	ewe and lamb = 200 lb

- 5) Estimate the maximum animal numbers that can be grazed on your pastures during an entire season:

$$\text{Number of animals} = \frac{(\text{total acreage}) \times (\text{average yield/acre})}{0.04^* \times (\text{average weight/animal}) \times (\text{total days grazed})}$$

For example, for a ewe and a lamb:

$$\text{Number of animals} = \frac{20 \text{ acres} \times 4000 \text{ lb/acre}}{0.04 \times 200 \text{ lb} \times 153 \text{ days}} = 65 \text{ ewes with lambs}$$

### How many acres do my animals need?

If you have a lot of pasture and a fixed number of livestock, you might want to use a less-intensive system to maximize production per head rather than per acre. The calculations below will tell you the minimum amount of land required to pasture your herd. Remember, you can always use more than the minimum.

The minimum amount of land needed to pasture your herd:

$$\text{Pasture acreage needed} = \frac{(\text{number of animals}) \times (\text{average weight/animal}) \times 0.04^* \times (\text{total days grazed})}{(\text{average yield/acre})}$$

For example, if you have 25 Holstein cows:

$$\text{Pasture acreage needed} = \frac{25 \text{ cows} \times 1300 \text{ lb/cow} \times 0.04 \times 153 \text{ days}}{4000 \text{ lb/acre}} = 49 \text{ acres}$$

*\*The 0.04 figure is used because livestock need to have daily access to approximately 4% of their live weight in forage (2.5% intake, 0.5% trampling loss, and 1% buffer). This figure may be decreased if you are willing to feed supplemental hay or grain during periods of low production.*

These calculations should be used only as guides to help you get started. Actual numbers will vary from site to site and from year to year because of variations in the weather, soil type, and pasture condition.



## Drought

During periods of drought, greater intensity of management will result in forage lasting longer into the drought. The key is to recognize that a drought is occurring and take appropriate action before forage reserves have fallen too low. Rest between grazing becomes more and more crucial as drought stress increases. As a general rule, during drought periods, more stubble should be left after grazing. This can most readily be done by feeding energy from a supplemental source along with the pasture. The supplement might be hay, corn silage, or corn.

Some farmers have set land aside to be grazed only during a drought. This should be extremely drought tolerant forage such as warm season grasses.

Early weaning of beef calves (at 3 months of age) is an appropriate pasture management technique during drought. Calves should be turned onto good quality pasture and be supplemented with several pounds of grain. Dams or ewes can then be maintained at a lower level of feed intake.

## Moving livestock

Moving livestock needn't be traumatic or time consuming for either you or your animals; an experienced rotational grazer can move 50 to 250 head of livestock in 15 minutes. Animals rapidly develop herding behavior when they are managed on pasture. Using principles of animal behavior, you can readily move large groups of animals from pasture to pasture with little difficulty.

The key to fast moves lies in minimizing animal stress. Avoid forcing your animals to go somewhere they don't want to go, especially by hitting or yelling at them. Instead, make your animals want to move. Move them when they're hungry and during the day when they can see where they're going. Livestock are very habitual creatures. If you move them at the same time each day, they will anticipate this, stop grazing, congregate near the gate, and wait for you to come. As soon as you open the gate, they'll move themselves, anticipating fresh pasture.

If you have difficulty moving them, don't make any quick movements and don't try to push them directly from behind. Instead, stand slightly to the side of them, walk towards them and they should start walking away from you. Alternately, leave the gate open and go away and they'll move themselves painlessly!

## Paddocks: How many and how big?

There is no "best" number of paddocks. Any number of paddocks is better than grazing a single pasture continuously. Initially, the number of paddocks in your rotational system may be determined by current fences, topography, access to water or access to a central collection corral or yard (as discussed in the next section). This may lead to a two- to eight-paddock system and will greatly increase both pasture condition and animal performance.

The next step is to move into an intensive grazing system and let the length of grazing and rest periods determine the number of paddocks. Dividing a pasture into more paddocks increases the length of the rest period and decreases the length of time an area is grazed (figure 10). More paddocks are usually better than fewer for both the animals and the plants. But paddock numbers don't need to be rigid; they may be fenced with portable electric wire so that size and number may be changed as needed.

**Figure 10.** Relationship between number of paddock and rest period per acre

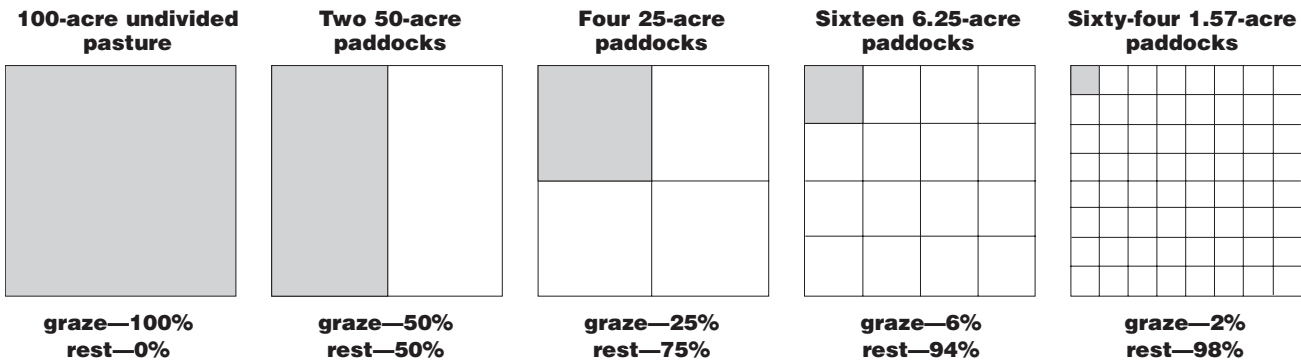

To determine the ideal number of paddocks for a management intensive rotational grazing system, estimate the length of your longest rest period (during the slowest period of forage growth), the length of your grazing period, and the number of animal groups which will be grazing the same pasture sequentially. Paddock numbers can then be calculated from the equation below:

$$\text{Number of paddocks} = \frac{(\text{rest period})}{(\text{grazing period})} + (\text{number of animal groups})$$

For example, a pasture with 30-day rest periods and 3-day grazing periods that is grazed by one animal group should be divided into 11 paddocks  $((30 \div 3) + 1)$ .

To figure out the approximate size of each paddock, divide total pasture acreage needed by the number of paddocks. The actual size of each paddock will need to be tailored to the site. Paddocks should be large enough to provide the optimum high-quality forage for each grazing period (calculate daily forage intake and fence off enough area in the paddock to meet animal needs). If paddock number and paddock size exceed your total acreage (for example, during summer or drought), plan on supplementing the animals' diet to reduce forage needs.

### Paddock layout

Most farmers have traditionally only pastured land that is not suitable for cultivation. But pasture needn't be relegated to your roughest land. In fact, after making good profits from pastures, many experienced rotational graziers have converted some of their best land to pasture. Just about any land can be pastured except excessively steep hillsides and dense woodlands. Fencing livestock out of woodlands allows young trees to survive and results in more marketable, higher-value timber.

After deciding how much of your land you want to pasture, you must determine how much of it cannot be harvested due to steepness of slope, rockiness, trees or brush. If pasture forage is to be your only source of feed for the summer, you'll probably want about half of your pasture to be land that can be mechanically harvested so you can put up hay in the spring to compensate for high spring productivity while having sufficient pasture for the summer.

The easiest way to lay out fencing is to make square or rectangular paddocks of uniform size (figure 11). This way, paddocks can easily be subdivided with mobile electric fence and calculations are easier because of uniform paddock areas. Square paddocks will use the least amount of fence for the greatest area. Another option is to make rectangular pastures and strip graze as shown in figure 12.

**Figure 11.** Square or rectangular paddock layout uses a central lane with shared waterers. Paddocks are separated by mobile or permanent fencing.

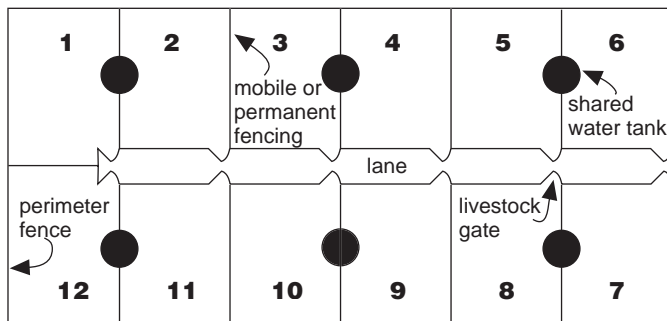

**Figure 12.** Strip grazing uses two wires that are moved along two permanent fences. Move the front wire according to pasture production and animal need. Follow with the back wire to prevent grazing of regrowth.

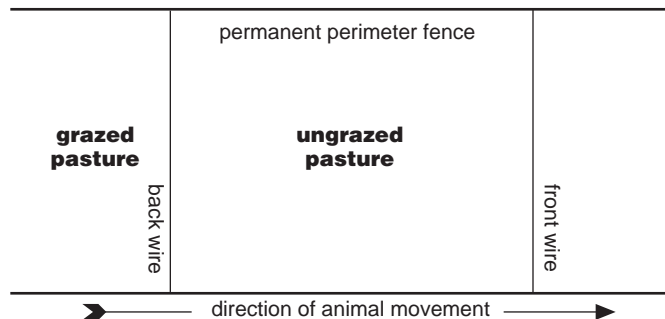

Unfortunately, using square or rectangular paddocks is not possible on most farms due to variations within a pasture and irregular pasture shapes. Paddocks should always be fenced so that the grazing environment within them is uniform. If a pasture has variations (in slope, shade, soil type, forage quality, etc.), both forage growth and grazing will be uneven. The rougher the terrain, the more complicated the fencing system must be to ensure even grazing. In uneven pastures, proper paddock placement is important in a rotational grazing system and essential in intensive rotational systems.

You may wish to use a couple of tools available from your county Natural Resources Conservation Service (NRCS) office to help you determine how to divide your pastures: a land use capability chart, a soils type map, a topographic map, and an aerial photograph of your pasture. To start out with, use the aerial photograph and maps to draw (or photocopy) a scaled map of your pasture land indicating the location of existing fencing, relevant buildings, roads, water sources, woodlands, and hills.

When separating pasture into paddocks, it is not necessary to completely change your current fencing system. As a general rule, it is best to use permanent perimeter fences and temporary internal fences. Fence paddocks with the following principles in mind:

### Topography

- Separate different slopes into different paddocks. Because a south-facing slope gets more sun, it may be ready to graze as much as 2 to 3 weeks before a north-facing slope on the other side of the same hill. South-facing slopes usually dry out faster in midsummer.
- Lay paddocks out across the slope (on the contour) rather than constructing a paddock running from top to bottom of a hill because pasture growth will be different on the top and bottom of a hill.
- Fence hill crests and valleys separately from slopes. Livestock often prefer to graze on level ground; if allowed, they will graze it more heavily than sloping land within the same paddock.

### Forage type

- Different forages will begin spring growth at different times and will produce different amounts of summer growth (figure 6).
- Grazing may hurt certain forages at certain times of the year and reduce persistence. For example, avoid grazing legumes between September 1 and October 15.

### Soil type

- Try to separate different soil types as much as possible. They will have different levels of productivity. For example, paddocks with good soils can often be grazed more frequently than those with droughty soils.
- Make sure appropriate forage species are planted in areas prone to flooding or drought.

### Shade and water availability

- Fence shady and sunny areas separately. This will prevent cattle from grazing the sunny areas and resting and leaving manure in the shade.
- Water should be accessible from each paddock.

### Other considerations

- Square or rectangular paddocks, while generally desired, are usually a bad choice for hilly and/or non-uniform land.
- Livestock lanes are more important the more frequently used. Dairy farms, for example, need more and better lanes than farms with other animals. Lanes should be located on high ground and should be as short as possible.
- Gates should be located in the corner of the paddock nearest to the barn.
- Stream banks may need to be fenced so they're not grazed when the ground is soft. Otherwise livestock will damage the embankment.
- Setting aside large open areas for hay-making during spring when excess pasture occurs will enhance nesting for grassland birds.

## Fencing

Good fencing is a must in rotational grazing systems. The fencing system used for rotational grazing includes a permanent perimeter fence as well as permanent or movable fencing to separate paddocks. For more information about the fencing options described below, contact your local fencing distributor.

### Permanent fencing

Most farmers use permanent fencing for perimeter fences and movable fencing for individual paddocks. Other farmers have chosen to construct permanent paddocks for all or part of their pastures. The advantage of permanent paddocks is that, once they are established, fences do not have to be moved. If your livestock numbers are fairly stable and you are experienced in rotational grazing, this may be a viable option.

Before buying new fencing, determine what permanent fencing you already have on your farm. Existing wooden or barbed wire fencing will work fine for the perimeter fence as long as it provides an effective barrier for the animals. To separate individual paddocks, you'll probably want to use temporary electric fencing as described in the next section. Don't let your current fencing arrangement limit you. Fence in a way that makes the best use of your land.

Consider the state of repair of the current fence. An old fence can be improved by adding a single electric wire on a strut that protrudes into the pasture (offset fence). Never electrify barbed wire since animals can cut themselves badly on the barbs when recoiling from a shock.

When constructing new perimeter fence, most farmers choose smooth, high-tensile wire since it is relatively cheap, long-lasting (about 30 years), fairly easy to move (if necessary), and highly effective. These fences can be constructed so that some or all of the strands can be electrified.

### Lightweight movable fencing

With movable fencing you can easily alter paddock size to meet changing conditions of forage growth or herd size. Pasture divided into temporary paddocks is easily accessed by machinery, or can easily be taken out of pasture all together.

Portable wires and tapes are made of polyethylene imbedded with stainless steel strands (the greater the number of metal strands, the longer it will last). Polywire is a braided wire and is available in a variety of colors and lengths. Brightly colored tape is more easily seen by livestock and therefore is good for training animals new to rotational grazing. Both kinds of fencing come on light-weight reels which can be easily moved and hooked on to perimeter fences. A single strand is all that is needed between temporary paddocks since electric fencing is a fear barrier rather than a physical barrier. (A second strand may be needed when very young animals are kept with mature animals.)

Lightweight plastic or fiberglass posts can be used to hold up the polywire. They are so light that 20 or 30 stakes can be carried at a time. Their narrow ends are easily inserted into the soil by stepping on a side lip with your foot, or pushing down from the top. Beware of splinters if you use fiberglass.

If you choose to use polyethylene wire or tape, you'll need to carefully select your fencer since ordinary, weed-burning chargers will melt the plastic. The best type of energizer on the market today is the New Zealand type, low impedance pulsating high energy charger. These give extremely short (0.0003 second), high-energy DC electrical pulses. Since the pulse is so fast and short, energy can't be drained off by weeds or by a section of fence that has fallen onto the soil. There is less need to trim weeds from underneath fences energized with New Zealand type energizers since they rarely short out.

## Lanes and laneways

Lanes allow for livestock movement from one paddock to any other paddock or to the barn without moving back through a previously grazed paddock or through an inadequately rested paddock. The need for lanes depends on the length of occupation of a paddock and the frequency of livestock movement. Animals can generally walk through a wet area once with minimal damage to the area but not twice. Thus, stable lanes are critical on a dairy operation where cattle need to move back and forth from the pasture to a milking facility at least twice daily; they are less important for other animals that are moved less frequently.

Lanes must be properly planned, located and built. The width should be kept as narrow as possible, 6 to 8 feet wide for cattle or 14 to 18 feet for cattle and machinery. Lanes can be formed by two parallel single strand electric fences with gates. If high-tensile wire is used, gates are not necessary. The wire can be unclipped from the post and held to the ground by a nail driven into the post at ground level. Another technique is to raise the wire in the air with another post for the livestock to walk under.

Lanes should be centrally positioned to access the field or paddocks to be grazed, including crop or hay fields that will be grazed temporarily. When lanes serve rotational pastures, they should be positioned to create paddocks that are as nearly square as possible. Also, placing lanes directly up and down steep slopes should be avoided if at all possible. If this is not possible, the lane should be reinforced with weatherproof surfacing. Equip any lane having long, continuous gradients with water diverters to break up waterflows directed down the lane.

Avoid driving equipment up and down non-surfaced lanes when wet. Livestock use the slightest wheel rut as a preferred trail. Continual use kills the vegetation and causes erosion to begin where water can channel and gather velocity in the trail.

In situations with frequent traffic, lanes should be surfaced. Inadequate lanes that are wet and muddy can cause animal health problems besides lengthening livestock travel time. Mastitis, high somatic cell counts, lameness, and reduced feed intake are some problems that can be attributed to poor lane design. For a dairy operation you should reinforce at least 1000 feet of lane closest to the milking facility and all areas that are unstable due to wetness or slope. There are many types of surfacing materials including concrete, asphalt, and rock with limestone screenings on top. For more information contact your local Conservation District, Land Conservation Department, Extension Service, or USDA-Natural Resources Conservation Service office.

All lanes should be crowned at least 6 inches to 12 inches in the center to provide drainage. Constructed fords, culvert crossings, or bridges should be used for stream crossings. Culvert crossings or bridges should be used sparingly. They should not be used at all if the stream is prone to flooding. Maintenance of crossings and bridges is high. Debris can easily plug the entrance. Damage to downstream areas caused by successive washouts of either abutment can also be excessive. If flooding occurs, it is generally safer to have a constructed ford with rock along the streambed. The rocks should be large enough to avoid becoming lodged in hooves, usually 4 inches or more. Crossings should be perpendicular to waterways and streams.

## Designing a pasture system

Tailor paddock layout to your own farm. The most important part in setting up a grazing system is putting what you know about your farm to work. Figure 13 is an example of how a "typical" farm might gradually move from continuous to rotational grazing. This farm has a 5-acre field at the top of a hill south of the buildings. There is a slope to the north and south of this pasture, a low area northwest of the buildings, and a south slope along the northern property line.

The land with buildings and existing perimeter fence is shown in the first drawing. The first step in switching to rotational grazing is to divide the land into four paddocks (drawing 2). To maintain water quality, the pond has been fenced off. Water will be pumped to a waterer in the barnyard. Each paddock has a gate at the barnyard. This avoids the need to create lanes and simplifies handling animals; it also allows a single water source to provide water for all paddocks. This setup is not necessary for most pasturing systems but essential for milking herds, which return to the barn daily. The paddock northeast of the buildings was fenced separately because it is reasonably flat and could be left for hay making when there is surplus forage. Different slopes were not fenced separately, but with just four divisions there are limits to how much fine tuning can be done. This fencing division to four paddocks will greatly improve production compared to the two-paddock system. The fencing can be either permanent or temporary and may be the final stage of setting up a 4-paddock system or the first step to establishing an intensive grazing system.

The third illustration in figure 13 shows the next set of divisions that should be made to go to an intensive grazing system. Each of the four paddocks has been further divided using portable fencing which can easily be moved, increased, or decreased in number. In this fencing refinement, the south-facing slopes were all fenced separately from other areas because they can be grazed earlier than other paddocks in the spring. The low area northwest of the pond was fenced into a separate paddock because production would be much higher than other areas during dry spells. Note that the paddocks are not all the same size. It is more important that the paddocks yield roughly equal amounts of forage than that they have equal areas.

When deciding how to divide your pasture, think about what you have to work with: existing fencing, permanent buildings, water sources, etc. Use these resources as much as possible.

### Deciding when to move livestock

For rotational grazing to be successful you must be flexible! Don't get into a rut of grazing every paddock in the "proper" sequence for the "proper" number of days and then follow your estimated rest period. The number of paddocks grazed and the lengths of the grazing and rest periods should vary as pasture growth rates change with the weather. The faster the pasture grows, the fewer paddocks you'll need and the shorter grazing and rest periods you'll need to take. During times of slow pasture growth, you'll need more paddocks and longer rest periods.

**Example 1.** Suppose you estimate the longest rest period of the season to be 32 days. If you allow 2 days in each paddock you'll need 17 paddocks in all [(rest period ÷ grazing period) + number of animal groups]. Anticipating faster growth rates in the spring, you estimate that the rest period will need to be only about 16 days to start out with. You decide to split the pasture in half in the spring, harvest half for hay and graze the other half. You begin grazing paddock #1 moving sequentially through all eight paddocks. But it has been a dry spring. By the time you've finished grazing paddock #8, paddock #1 isn't ready to be grazed yet. What do you do? Graze some of the land you were setting aside to make hay until paddock #1 is ready to be grazed (or feed stored feed)? A better solution would be to anticipate this slow growth in time to slow down the rotation.

**Figure 13.** Example of how a farm might gradually implement rotational grazing

1. Add a division fence

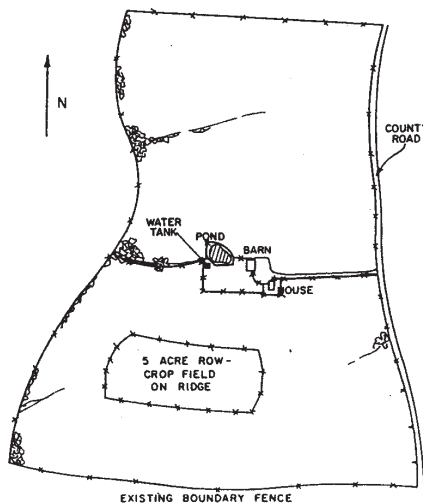

2. Subdivide the land into four paddocks using permanent (x-x-x) and temporary (— —) fencing

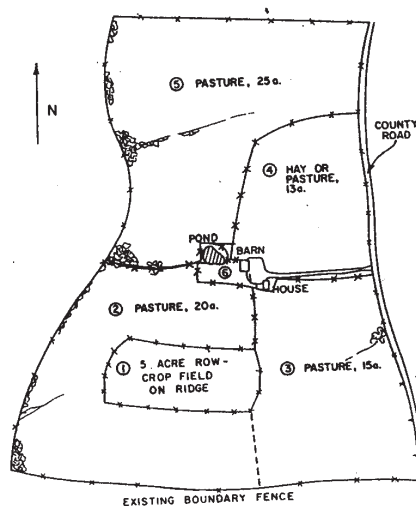

3. To move to intensive rotational grazing, subdivide the land into eight paddocks using portable fence

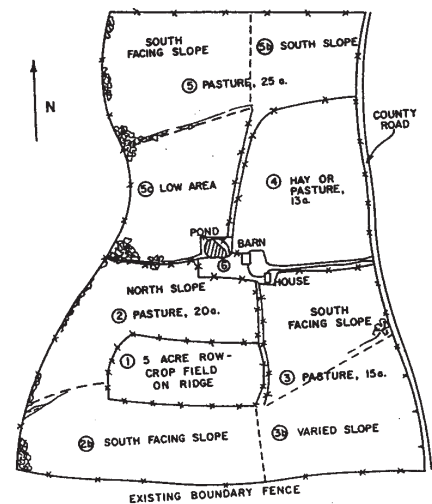

Source: University of Kentucky Cooperative Extension Service publication Planning Fencing Systems for Intensive Grazing Management (ID-74)

**Example 2.** On the other extreme, it is midsummer, the weather has been rainy and cooler than usual. You are on paddock #10 in a 16-paddock rotation when you notice that paddock #1 is ready to be grazed again. If you follow your planned rotation, paddock #1 will be over-mature by the time you get to it. What do you do? Graze paddock #1 out of sequence. You can mow or hay the paddocks that you didn't get to in this round so they'll be ready later in the season.

What if you don't want to (or can't) make hay during periods of rapid forage growth? Move the animals faster from one paddock to the next. The animals will "top" the paddocks, grazing the most nutritious forage, leaving the rest. Under this system, forage is wasted but only the lower quality forage will be lost. The less-desirable alternative is to use the same grazing period length you would have used under "normal" growing conditions. Because of rapid growth, the paddocks yet to be grazed would become over-mature and even more forage would be lost as well as animal productivity.

## Evaluating and improving your grazing system

If you are interested in intensifying your current grazing system or making a transition from confinement feeding to pasturing, do so gradually. It takes a while to attain good stands and pasture forage yields. Rotational grazing requires new forage management skills, which take time to develop.

In order to evaluate and improve your rotational grazing system, it may be helpful to draw up a "pasture calendar." This calendar should span the entire year and be subdivided into monthly and weekly sections. Leave enough space to record timely observations of your pasture and animals, management plans, and new ideas.

### 1. Animal observations

Try to match animal needs with forage production.

- Record animal health problems you think might be related to grazing.
- Keep track of stocking rates. Are the rates high enough to prevent spot grazing?
- Are your livestock developing "camp" areas? How can this be avoided?
- Are your livestock getting enough feed from pasture? Why or why not? Is there significant trampling loss? Are you feeding them too much non-pasture feed in the barn?
- Is production at desired levels? Do you need to feed supplement or renovate your pastures?

### 2. Pasture observations

- Keep track of rest and grazing periods. How is your pasture responding to these? Do your pastures recover slowly (a sign of overgrazing)? Are they getting ahead of you? How do you respond?
- Keep track of which pastures you grazed so you know how much rest they need.
- Keep track of the growth stage of your forages. How long does it take to reach the optimal stage for grazing?
- How much stubble are you leaving? Is pasture recovery fast enough?
- How do you plan to deal with the midsummer slump?
- How will you extend the grazing season?
- If you plan to stockpile forage, how much forage do you need?

# Animal health on pasture



## Parasites

**G**razing livestock (especially grazing intensively) can lead to increased parasite infestation. Since early signs of an infested herd are not always obvious, producers often fail to treat animals until they see visible symptoms such as diarrhea, sunken flanks, or “bottle jaw.” By this time, significant herd production losses have already occurred. Infected animals show greater susceptibility to disease, general lack of vigor, slow growth, low milk production, and low weight gains. Although parasites affect young animals most severely, all livestock are detrimentally affected.

Understanding the general parasite life cycle aids in being able to control or prevent infections. Infected animals spread parasites quickly and effectively, putting an entire herd at risk. One cow can shed up to 400,000 worm eggs per day in its manure. Under warm and moist conditions, these eggs hatch into infective, mobile larvae, which move out onto pasture forage. After being eaten by livestock, the ingested larvae become egg-laying adults in about 3 weeks, eventually releasing thousands more eggs which come out with manure. Though hot, dry weather kills most larvae, some survive in soil, in manure pats, or under vegetation. Surviving larvae overwinter beneath the snow to reinfect livestock the following spring.

The key to parasite control is prevention. It is best to de-worm livestock before they are put to pasture in the spring to kill any adult worms still in their bodies. (Check product label for restrictions before de-worming pregnant stock.) Since livestock will probably ingest overwintering larvae in the pasture while grazing, worm them again 3 to 4 weeks later when larvae have matured but before they release more eggs. A follow-up worming in another 3 to 4 weeks is also advisable. Try to treat immediately before livestock are moved to a new paddock to prevent contamination of new paddocks.

De-worming is simpler than it used to be due to de-wormer blocks, feed premixes, and medicated mineral salts which eliminate the need to round up livestock separately for treatment. Make sure to use the new broad-spectrum de-wormers which are effective against all larval and adult stages of worms.

## Bloat

Bloat is most often a problem when grazing high-quality, lush legume pastures (except birdsfoot trefoil), lush young grasses, or brassicas. Foam-producing compounds in the immature plants cause stable foam formation in the rumen of susceptible animals, prohibiting them from belching rumen gas. This condition, if not treated immediately, can lead to death. Individual animals differ in their susceptibility to bloat.



Bloat can be a serious problem if hungry livestock are turned out on young, lush legume pasture (greater than 50% legumes). Listed below are some ways to prevent bloat:

- 1) Don't graze hungry livestock on pure legume pastures (except birdsfoot trefoil). Play it safe by planting grass with your legume. Also, feed them with hay before turning out and let them graze only 2 to 3 hours for the first 2 to 4 days of the grazing season. And finally, once on pasture leave livestock there continuously so they don't gorge themselves.
- 2) Moving cattle frequently (every 1 to 4 days) to new pasture will keep animals from getting hungry towards the end of grazing one paddock and gorging themselves when placed in a fresh pasture.
- 3) Feed poloxalene, an anti-foaming agent. Give to cattle before turning onto pasture and continue throughout the season. The effectiveness of poloxalene depends on daily consumption. Mix with a daily feed supplement. Avoid supplying it as a block or mineral mix as this allows non-uniform daily feeding and is less effective.
- 4) Don't graze legumes or brassicas with lots of rain or dew on them, especially in autumn.
- 5) Don't graze grass or legume pastures at immature stages, before they have regrown.
- 6) Plant birdsfoot trefoil, a non-bloating legume.

Bloat can "sneak up on you." One farmer, in his first year of rotational grazing, complained of having bloat problems on a pasture that never gave any problems when grazed continuously. It turns out that he was leaving his cattle on one paddock so long that in the last days before moving, they were grazing extremely poor-quality forage and were very hungry. When turned onto a fresh paddock, they gorged themselves on lush legume/grass forage and bloat became a problem.

### Nitrate poisoning and poisonous plants

Nitrate poisoning acts very quickly and symptoms may not be observed until an animal drops dead. Primarily older and very young animals are affected. Certain plants, such as lambsquarters, pigweed, and annual grains, tend to have a greater concentration of nitrates than others. Nitrate accumulation is especially a problem during periods of slow growth initiated by drought, shade, or herbicide application. Application of manure and/or nitrogen fertilizer also increases nitrate content of forage. Nitrates can also be high in well water the animals drink.

If you suspect a potential for nitrate poisoning, have your forage tested. Levels above 0.1% may affect animal production (depending on animal age, nutritional requirements, and whether or not pregnant). Levels above 0.35% nitrate-nitrogen may be lethal.

There are a few steps you can take to help decrease the risk of chronic nitrate toxicity. Supplement forages that have potentially toxic nitrate levels with low-nitrate forages. Avoid unnecessary fertilization. And do not graze pastures with high numbers of lambsquarters and pigweed during periods of drought.

Poisonous plants are seldom a problem in the Midwest because they generally taste bitter and will be avoided as long as other forage is available.





## Additional reading

### Books

*Grass Productivity* by Andre Voisin. 1993. Washington, D.C.: Island Press. 353 pages.

*Grazing Management: Science into Practice* by John Hodgson. 1990. New York: Longman Scientific & Technical. 203 pages.

*Greener Pastures on Your Side of the Fence: Better Farming with Voisin Grazing Management* by Bill Murphy. 1999. Colchester, Vermont: Arriba Publishing. 379 pages.

*Holistic Resource Management* by Allan Savory. 1988. Washington, D.C.: Island Press. 558 pages.

*How to Plan, Implement, and Practice Controlled Grazing on Your Place* by Bob Kingsbury. 1989. Woodinville, Washington: Kingsbury Communications. 57 pages.

*Intensive Grazing Management. Forage, Animals, Men, Profits* by Burt Smith, Pingsun Leung and George Love. 1986. Kamuela, Hawaii: The Graziers Hui. 350 pages.

### Web sites

*University of Wisconsin-Extension Team Forage*: [www.uwex.edu/ces/crops/uwforage/uwforage.htm](http://www.uwex.edu/ces/crops/uwforage/uwforage.htm)

*Great Lakes Grazing Network*: [www.glgln.org](http://www.glgln.org)

## Acknowledgments

The following agencies and organizations cooperated in the development and publication of this pamphlet:

- Department of Agriculture, Trade and Consumer Protection, Sustainable Agriculture Program;
- Department of Natural Resources, Bureau of Wildlife Management;
- Wisconsin Nutrient and Pest Management program with the Center for Integrated Agricultural Systems, University of Wisconsin, College of Agricultural and Life Sciences;
- University of Wisconsin-Extension, Cooperative Extension; and
- University of Minnesota-Extension.

Thanks also to the farmers whose experiences and expertise in using rotational grazing on their farms added greatly to the production of this publication.



© 2002 by the Board of Regents of the University of Wisconsin System. Send inquiries about copyright permissions to Cooperative Extension Publishing, Rm. 103, 432 N. Lake St., Madison, WI 53706.

**Authors:** Dan Undersander is a forage agronomist with the College of Agricultural and Life Sciences, University of Wisconsin-Madison and University of Wisconsin-Extension; Beth Albert is a technical writer, formerly with the University of Wisconsin-Madison; Dennis Cosgrove is a forage agronomist with the University of Wisconsin-River Falls and University of Wisconsin-Extension; Dennis Johnson is a dairy scientist with the University of Minnesota-Morris; and Paul Peterson is a forage agronomist with the University of Minnesota. The authors wish to thank Neal Martin and Pamela Porter for their contributions to earlier versions of this publication.

Produced by **Cooperative Extension Publishing**, University of Wisconsin-Extension. Edited by Linda Deith and designed by Susan Anderson.

University of Wisconsin-Extension, Cooperative Extension, and Minnesota Extension Service, in cooperation with the U.S. Department of Agriculture, provide this information to further the purpose of the May 8 and June 30, 1914 Acts of Congress; and provide equal opportunities in employment and programming, including Title IX and ADA. If you need this material in another format, contact the Office of Equal Opportunity and Diversity Programs or call Extension Publishing at 608/262-2655.

You can get copies of this publication from your Wisconsin or Minnesota county Extension office or from Cooperative Extension Publications, 45 N. Charter St., Madison, WI 53715, 608/262-3346. Outside Madison, call toll free: 1-877/WIS-PUBS (947-7827).

For more Cooperative Extension information, visit our web site: [www1.uwex.edu/ces/pubs/](http://www1.uwex.edu/ces/pubs/)